

SERVICE MANUAL



Color Inkjet Printer

EPSON Stylus PHOTO 810/820



EPSON®

Notice

- All rights reserved. No part of this manual may be reproduced, stored in a retrieval system, or transmitted in any form or by any means electronic, mechanical, photocopying, or otherwise, without the prior written permission of SEIKO EPSON CORPORATION.
- The contents of this manual are subject to change without notice.
- All effort have been made to ensure the accuracy of the contents of this manual. However, should any errors be detected, SEIKO EPSON would greatly appreciate being informed of them.
- The above notwithstanding SEIKO EPSON CORPORATION can assume no responsibility for any errors in this manual or the consequences thereof.

EPSON is a registered trademark of SEIKO EPSON CORPORATION.

General Notice: Other product names used herein are for identification purpose only and may be trademarks or registered trademarks of their respective owners. EPSON disclaims any and all rights in those marks.

Copyright © 2000 **SEIKO EPSON CORPORATION.**
TPCS Quality Assurance Dept.

PRECAUTIONS

Precautionary notations throughout the text are categorized relative to 1) Personal injury and 2) damage to equipment.

DANGER Signals a precaution which, if ignored, could result in serious or fatal personal injury. Great caution should be exercised in performing procedures preceded by DANGER Headings.

WARNING Signals a precaution which, if ignored, could result in damage to equipment.

The precautionary measures itemized below should always be observed when performing repair/maintenance procedures.

DANGER

1. ALWAYS DISCONNECT THE PRODUCT FROM THE POWER SOURCE AND PERIPHERAL DEVICES PERFORMING ANY MAINTENANCE OR REPAIR PROCEDURES.
2. NO WORK SHOULD BE PERFORMED ON THE UNIT BY PERSONS UNFAMILIAR WITH BASIC SAFETY MEASURES AS DICTATED FOR ALL ELECTRONICS TECHNICIANS IN THEIR LINE OF WORK.
3. WHEN PERFORMING TESTING AS DICTATED WITHIN THIS MANUAL, DO NOT CONNECT THE UNIT TO A POWER SOURCE UNTIL INSTRUCTED TO DO SO. WHEN THE POWER SUPPLY CABLE MUST BE CONNECTED, USE EXTREME CAUTION IN WORKING ON POWER SUPPLY AND OTHER ELECTRONIC COMPONENTS.
4. WHEN DISASSEMBLING OR ASSEMBLING A PRODUCT, MAKE SURE TO WEAR GLOVES TO AVOID INJURIER FROM METAL PARTS WITH SHARP EDGES.

WARNING

1. REPAIRS ON EPSON PRODUCT SHOULD BE PERFORMED ONLY BY AN EPSON CERTIFIED REPAIR TECHNICIAN.
2. MAKE CERTAIN THAT THE SOURCE VOLTAGES IS THE SAME AS THE RATED VOLTAGE, LISTED ON THE SERIAL NUMBER/ RATING PLATE. IF THE EPSON PRODUCT HAS A PRIMARY AC RATING DIFFERENT FROM AVAILABLE POWER SOURCE, DO NOT CONNECT IT TO THE POWER SOURCE.
3. ALWAYS VERIFY THAT THE EPSON PRODUCT HAS BEEN DISCONNECTED FROM THE POWER SOURCE BEFORE REMOVING OR REPLACING PRINTED CIRCUIT BOARDS AND/OR INDIVIDUAL CHIPS.
4. IN ORDER TO PROTECT SENSITIVE MICROPROCESSORS AND CIRCUITRY, USE STATIC DISCHARGE EQUIPMENT, SUCH AS ANTI-STATIC WRIST STRAPS, WHEN ACCESSING INTERNAL COMPONENTS.
5. REPLACE MALFUNCTIONING COMPONENTS ONLY WITH THOSE COMPONENTS BY THE MANUFACTURE; INTRODUCTION OF SECOND-SOURCE ICs OR OTHER NONAPPROVED COMPONENTS MAY DAMAGE THE PRODUCT AND VOID ANY APPLICABLE EPSON WARRANTY.

About This Manual

This manual describes basic functions, theory of electrical and mechanical operations, maintenance and repair procedures of the printer. The instructions and procedures included herein are intended for the experienced repair technicians, and attention should be given to the precautions on the preceding page.

Manual Configuration

This manual consists of six chapters and Appendix.

CHAPTER 1.PRODUCT DESCRIPTIONS

Provides a general overview and specifications of the product.

CHAPTER 2.OPERATING PRINCIPLES

Describes the theory of electrical and mechanical operations of the product.

CHAPTER 3.TROUBLESHOOTING

Describes the step-by-step procedures for the troubleshooting.

CHAPTER 4.DISASSEMBLY / ASSEMBLY

Describes the step-by-step procedures for disassembling and assembling the product.

CHAPTER 5.ADJUSTMENT

Provides Epson-approved methods for adjustment.

CHAPTER 6.MAINTENANCE

Provides preventive maintenance procedures and the lists of Epson-approved lubricants and adhesives required for servicing the product.

CHAPTER 7.APPENDIX

Provides the following additional information for reference:

- Connector pin assignments
- Electric circuit boards components layout
- Electrical circuit boards schematics
- Exploded diagram & Parts List

Symbols Used in this Manual

Various symbols are used throughout this manual either to provide additional information on a specific topic or to warn of possible danger present during a procedure or an action. Be aware of all symbols when they are used, and always read NOTE, CAUTION, or WARNING messages.



Indicates an operating or maintenance procedure, practice or condition that, if not strictly observed, could result in injury or loss of life.



Indicates an operating or maintenance procedure, practice, or condition that, if not strictly observed, could result in damage to, or destruction of, equipment.



May indicate an operating or maintenance procedure, practice or condition that is necessary to accomplish a task efficiently. It may also provide additional information that is related to a specific subject, or comment on the results achieved through a previous action.



Indicates an operating or maintenance procedure, practice or condition that, if not strictly observed, could result in injury or loss of life.



Indicates that a particular task must be carried out according to a certain standard after disassembly and before re-assembly, otherwise the quality of the components in question may be adversely affected.

Revision Status

Revision	Issued Date	Description
A	2001/8/23	First Release

PRODUCT DESCRIPTION

FEATURES	9
SPECIFICATIONS.....	10
Physical Specification.....	10
Printing Specification.....	10
Paper Feeding.....	11
Paper Specification	11
Plain Paper 11	
Envelope 12	
Exclusive paper 12	
Printing Area.....	14
Cut Sheet 14	
Envelopes 15	
Ink Cartridge Specification	15
Black Ink Cartridge 15	
Color Ink Cartridge 16	
Electric Specification	16
Environmental Condition	17
Reliability	17
Safety Approvals	17
Acoustic Noise.....	17
CE Marking.....	17
INTERFACE	18
Parallel Interface (Forward Channel)	18
Parallel Interface (Reserve Channel)	21
USB Interface	22
Prevention Hosts of Data Transfer Time-out.....	23
Interface Selection.....	23
IEEE1284.4 Protocol.....	23
PANEL CONTROL	24
Indicators (LEDs).....	24
Panel Functions.....	25
Printer Condition and Panel Status	25
Error Status	26
Printer Initialization.....	26

Operating Principles

Overview	28
Printer Mechanism	28
Printhead.....	29
Printing Process 30	
Printing Method 30	
Carriage Mechanism	31
Paper Loading/Feeding Mechanism	32
Paper Loading Mechanism (ASF unit) 33	
Paper Feeding Mechanism 36	
Ink System Mechanism	37
Capping Mechanism 37	
Pump unit mechanism 39	
Ink Sequence	40
Electrical Circuit Operating Principles	42
C417 PSB/PSE board	42
C418 MAIN/MAIN-B Board	45
Main Elements 46	
Printhead Driver Circuit 47	
PF Motor (PF/ PUMP/ ASF Motor) Driver Circuit 48	
CR Motor Driver Circuit 48	
Reset Circuit 49	
EEPROM Control Circuit 49	
Sensor Circuit 50	
<i>Troubleshooting</i>	
Overview	52
Troubleshooting with LED Error Indications and Status Monitor 3 Message.....	53
Unit Level Troubleshooting.....	58
<i>Disassembly and Assembly</i>	
Overview	80
Precautions	80
Tools	82
Screws.....	82

Work Completion Check.....	83
Disassembly	84
Upper housing removal	85
Printhead removal	87
CR unit removal.....	89
CR motor removal	92
ASF unit removal.....	93
PSB/PSE unit removal	95
Holder shaft unit removal	98
Circuit board removal	102
Waste drain ink pad (under the ASF unit) removal	105
Lower housing removal	106
Caution regarding Ink system removal, PF roller unit removal and PF motor removal	110
Ink system unit removal (Cap unit, Pump unit & Waste drain ink pad)	111
PF roller unit removal	114
PF motor removal.....	116

Electrical Circuits.....	142
--------------------------	-----

Adjustment

Overview.....	118
Required Adjustment.....	118

Maintenance

Overview.....	120
Cleaning	120
Service Maintenance.....	120
Lubrication.....	122

Appendix

Connector Summary.....	126
Major Component Unit	126
EEPROM Address Map.....	128
Component Layout	132
Exploded Diagram	134
Parts List.....	140

CHAPTER

1

PRODUCT DESCRIPTION

1.1 FEATURES

The major features of EPSON color inkjet dot matrix printer EPSON Stylus PHOTO 810/820 are:

- High Color Print Quality
 - 2880 (H) X 720 (V) dpi printing
 - Six Color Printing (YMCKmc)
 - Traditional and New Microweave
- Built-in Auto Sheet Feeder
 - Holds 100 cut-sheets (65g/m²)
 - Holds 10 envelopes
 - Holds 10 transparency films
- Two built-in Interfaces
 - Bi-directional parallel I/F (IEEE-1284 level 1 device)
 - USB
- Windows/Macintosh exclusive

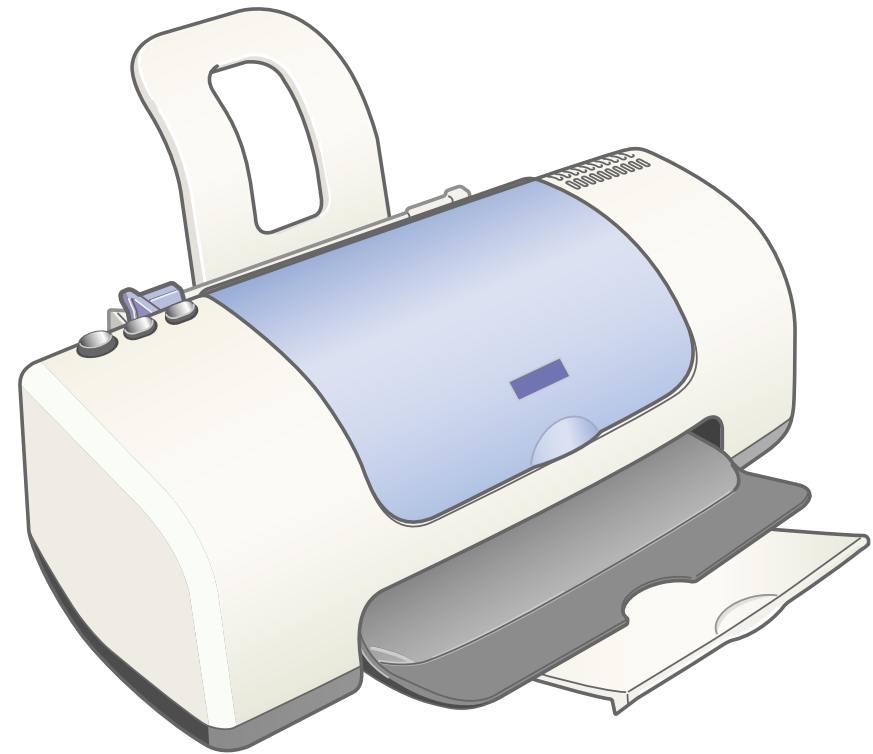

Figure 1-1. Product's external view

1.2 SPECIFICATIONS

This section covers specifications of the printer.

1.2.1 Physical Specification

- Weight : 3.42 kg (without the ink cartridges)
- Dimension Printing : 479.6 mm (W) x 509 mm (D) x 271.8 mm (H)

1.2.2 Printing Specification

- Print Method
 - On demand ink jet
- Nozzle Configuration
 - Monochrome 48 nozzles
 - Color 48 nozzles x 5 (Cyan, Magenta, Yellow, Light Cyan, Light Magenta)

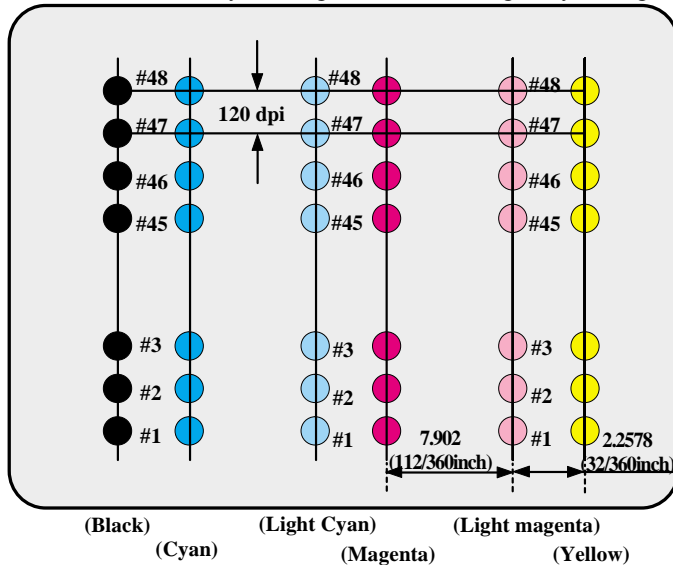

Figure 1-2. Nozzle configuration

- Print Direction
 - Bi-direction with logic seeking
- Print Speed & Printable Columns

Table 1-1. Character mode (Black only)

Character pitch	Character quality	Printable columns	CR speed
10 CPI	LQ	80	238 CPS*

*CPS: Characters/Second

Table 1-2. Raster graphics mode

Horizontal resolution	Printable area	Available dot	CR speed
360 dpi (Normal dot)	209.8 mm (8.26 inch)	2976	86.36 cm/s (34.0 IPS*)
360 dpi (Multi shot 3 dot)	209.8 mm (8.26 inch)	2976	60.452 cm/s (23.8 IPS*)
720 dpi	209.8 mm (8.26 inch)	5952	50.80 cm/s (20 IPS*)
1440 dpi	209.8 mm (8.26 inch)	11904	50.80 cm/s (20 IPS*)

* IPS: Inch/Second

- Control Code
 - ESC/P Raster command
 - EPSON Remote command
- Character Tables
 - None
 - ASCII 96 Codes (Code Number 20H-7FH)
- International character sets
 - None

- Typeface
 - Bit map LQ font : EPSON Courier 10 CPI
- Input Data Buffer
 - 32 KB

1.2.3 Paper Feeding

- Feeding Method
 - Friction feed with ASF
- Paper Path
 - Cut-sheet ASF (Top entry Front out)
- Feed Speed

Table 1-3. Feed speed

Feed condition	Time	Speed
10.16 mm (0.4 inch) feed	110 msec	92.36 mm (3.64 inch)/sec
Continuous feed	140 msec	139.7 mm (5.5 inch)/sec

1.2.4 Paper Specification

1.2.4.1 Plain Paper

Table 1-4. Plain paper

Item	Width (mm)	Length (mm)	Thickness (mm)	Weight (g/m ²)	Quality
A4	210	297	0.08-0.11	64-90 (17-24(lb))	Plain paper Reclaimed paper
Letter	215.9	279.4			
Legal	215.9	355.6			
Executive	184.2	266.7			
Half Letter	139.7	215.9			
B5	182	257			
A5	148	210			
A6	105	148			
User defined	89-241.3	89-1117.6			



- Poor quality paper may reduce print quality and cause paper jams or other problems. If you encounter problems, switch to a higher grade of paper.
- Do not load curled or folded paper.
- Use paper under normal conditions : Temperature 15 to 25°C (59 to 77°F) Humidity 40 to 60% RH

1.2.4.2 Envelope

Table 1-5. Envelope

Item	Width (mm)	Length (mm)	Thickness (mm)	Weight (g/m ²)	Quality *
No.10	241.3	104.8	N/A	45-75 (12-20(lb))	Bond paper Air mail PPC
DL	220	110			
C6	162	114			
Envelope 220*132	220	132			

* Envelope printing is only available at normal temperature.
Keep the longer side of the envelope horizontally at setting.



- **Poor quality paper may reduce print quality and cause paper jams or other problems. If you encounter problems, switch to a higher grade of paper.**
- **Do not load curled or folded paper.**
- **Use paper under normal conditions : Temperature 15 to 25°C (59 to 77°F) Humidity 40 to 60% RH**

1.2.4.3 Exclusive paper

Quality: EPSON Exclusive paper

Transparency printing is only available at normal temperature

Table 1-6. Exclusive paper

Item	Size	Width (mm)	Length (mm)	Thickness (mm)	Weight (g/m ²)
Photo Quality Ink Jet Paper	A4	210	297	0.13	102 (27lb) *
	Letter	215.9	279.4		102 (27lb)
	Legal	215.9	355.6		
	B5	182	257		
Photo Quality Ink Jet Card	5*8	127	203.2	0.21	180 (48lb)
	8*10	203.2	254		
	A6	105	148		
360dpi Ink Jet Paper	A4	210	297	0.11	89 (24lb)
	Letter	215.9	279.4		
Premium Luster Photo Paper	Letter	215.9	279.4	0.27	250 (66lb)
Ink Jet Transparencies	A4	210	297	0.13	N/A
	Letter	215.9	279.4		
Photo Quality Glossy Film	A4	210	297	0.13	N/A
	Letter	215.9	279.4		
	A6	105	148		
Matte Paper-Heavyweight	A4	210	297	0.23	167(44lb)
	Letter	215.9	279.4		

Table 1-6. Exclusive paper

Item	Size	Width (mm)	Length (mm)	Thickness (mm)	Weight (g/m ²)
Photo Paper	A4	210	297	0.23	194 (52lb)
	Letter	215.9	279.4		
	Card	100	148		
	Photo Paper 4*6	113.6	175.4		
	Panorama	210	594		
Photo Quality Self Adhesive Sheets	A4	210	297	0.19	167 (44lb)
Photo Stickers 16	A6	105	148	0.19	167 (44lb)
Photo Stickers 4	A6	105	148	0.19	167 (44lb)
Iron-On Cool Peel Transfer Paper	A4	210	297	0.18	124 (33lb)
	Letter	215.9	279.4		
Premium Glossy Photo Paper	A4	210	297	0.27	255 (68lb)
	Letter	215.9	279.4		
Premium Semigloss Photo Paper	A4	210	297	0.27	250 (66lb)
	Letter	215.9	279.4		
Premium Ink Jet Plain Paper	A4	210	297	0.11	80 (21lb)
Bright White Ink Jet Paper	A4	210	297	0.13	92.5 (25lb)

* 98 (26lb) for EU



- Poor quality paper may reduce print quality and cause paper jams or other problems. If you encounter problems, switch to a higher grade of paper.
- Do not load curled or folded paper.
- Use paper under normal conditions : Temperature 15 to 25°C (59 to 77°F) Humidity 40 to 60% RH
- EPSON Photo Quality Glossy Film and Self Adhesive Sheets should be stored under the following conditions : Temperature 15 to 30°C (59 to 86°F) Humidity 20 to 60% RH

1.2.5 Printing Area

1.2.5.1 Cut Sheet

Refer to the following table. As for each margin area, refer to Figure 1-3.

Table 1-7. Printing area

Paper size	Left margin (min.) **	Right margin (min.) **	Top margin (min.) **	Black bottom margin (min.) **
A4	3 mm (0.12")	3 mm (0.12")	3 mm (0.12")	14 mm (0.54") / 3mm (0.12") *
Letter	3 mm (0.12")	3 mm (0.12")	3 mm (0.12")	14 mm (0.54") / 3mm (0.12") *
B5	3 mm (0.12")	3 mm (0.12")	3 mm (0.12")	14 mm (0.54") / 3mm (0.12") *
Legal	3 mm (0.12")	3 mm (0.12")	3 mm (0.12")	14 mm (0.54") / 3mm (0.12") *
Statement	3 mm (0.12")	3 mm (0.12")	3 mm (0.12")	14 mm (0.54") / 3mm (0.12") *
Executive	3 mm (0.12")	3 mm (0.12")	3 mm (0.12")	14 mm (0.54") / 3mm (0.12") *

* Bottom margin can be set to 3mm when the paper length is designated with “ESC (S” command). However, the printing quality is not guaranteed in the area, ranging from 3mm to 14mm, from the form lower end. When the paper length is not designated, the bottom margin must be wider than 14mm. (Printable area A)

** When all margins (Left / Right / Top / Bottom) can be set to 0mm at minimum only when the “no margin” is checked on the printer driver. However, the printing quality is not guaranteed in the area, ranging from 0mm to 3mm, from the form lower end.

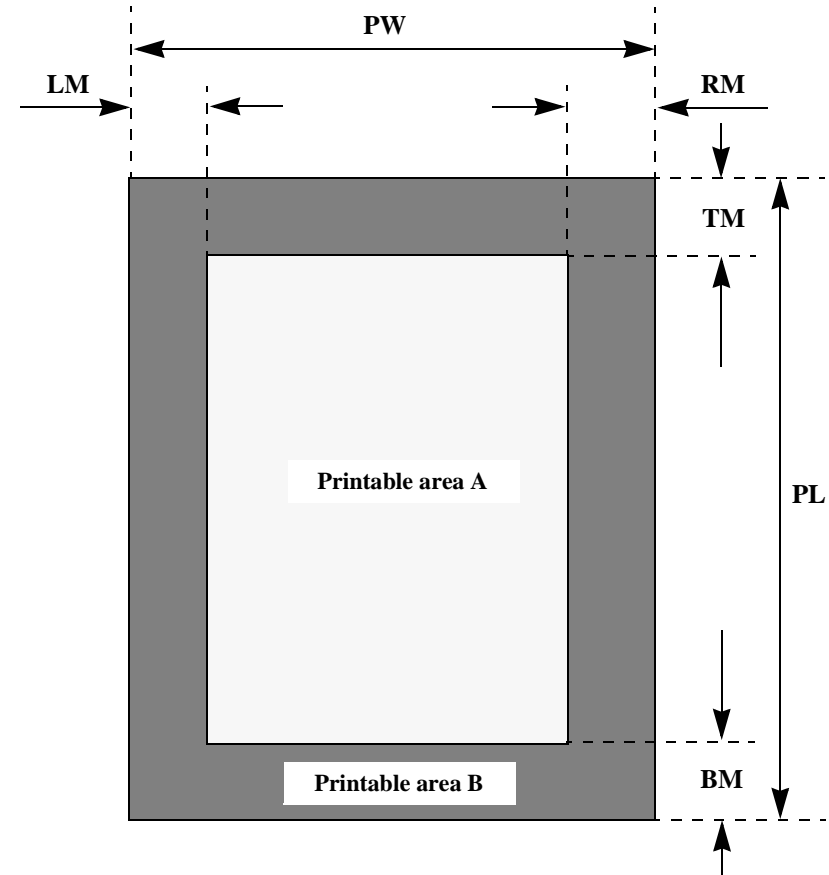

Figure 1-3. Printable area for cut sheet

1.2.5.2 Envelopes

Refer to the following table. As for each margin area, refer to Figure 1-4.

Table 1-8. Envelope margin

Paper size	Left margin (min.)	Right margin (min.)	Top margin (min.)	Bottom margin (min.)
#10	3 mm (0.12")	28 mm (1.10")	3 mm (0.12")	14 mm (0.55")
DL	3 mm (0.12")	7 mm (0.28")	3 mm (0.12")	14 mm (0.55")
C6	3 mm (0.12")	3 mm (0.12")	3 mm (0.12")	14 mm (0.55")

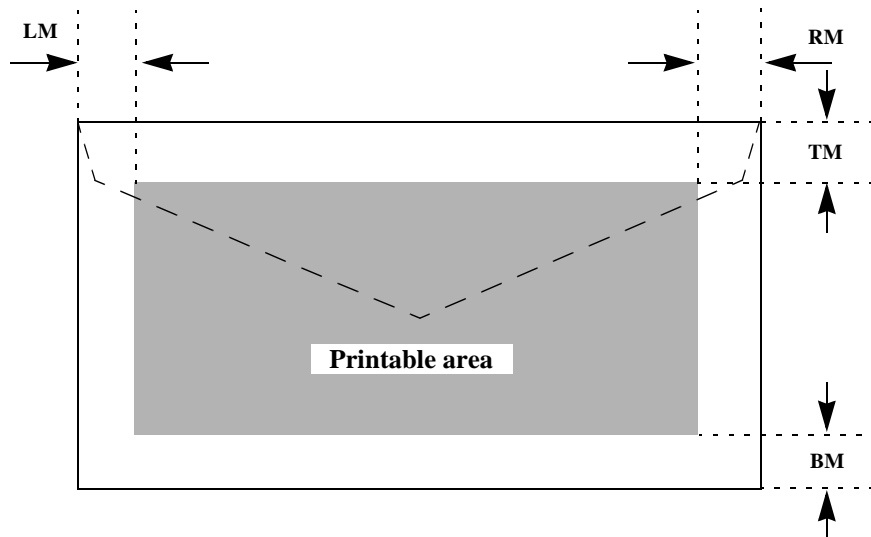

Figure 1-4. Printable area for envelopes

1.2.6 Ink Cartridge Specification

1.2.6.1 Black Ink Cartridge

- Type : Exclusive Cartridge
- Color : Black
- Print Capacity : 540 pages/A4
(ISO/IEC 10561 Letter Pattern at 360 dpi)
- Ink Life : 2 years from production date
- Storage Temperature:
 - Storage -20 °C to 40 °C (within a month at 40 °C)
 - Packing -30 °C to 40 °C (within a month at 40 °C)
 - Transit -30 °C to 60 °C (within 120 hours at 60 °C and within a month at 40 °C)
- Dimension : 20.1 mm (W) x 66.85 mm (D) x 38.5 mm (H)

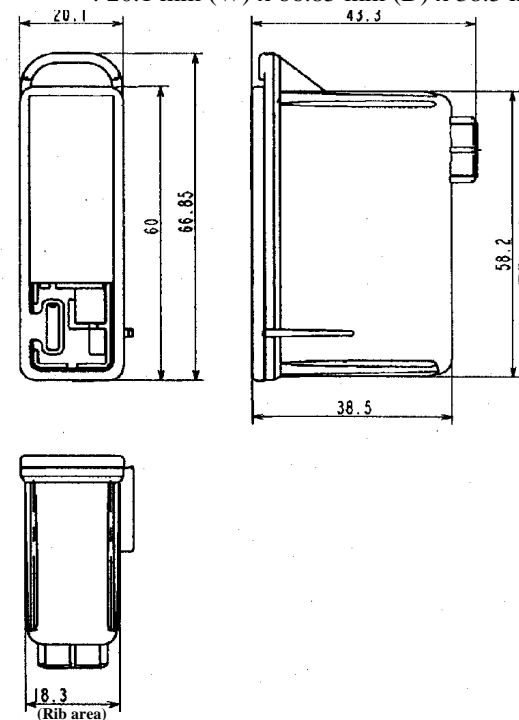

Figure 1-5. Black ink cartridge

1.2.6.2 Color Ink Cartridge

- Type : Exclusive Cartridge
- Color : Magenta, Cyan, Yellow, Light Cyan, Light Magenta
- Print Capacity : 220 pages / A4 (360 dpi, 5% duty each color)
- Ink Life : 2 years from production date
- Storage Temperature:
 - Storage -20 °C to 40 °C (within a month at 40 °C)
 - Packing -30 °C to 40 °C (within a month at 40 °C)
 - Transit -30 °C to 60 °C (within 120 hours at 60 °C and within a month at 40 °C)
- Dimension : 49.1 mm (W) x 66.85 mm (D) x 38.5 mm (H)

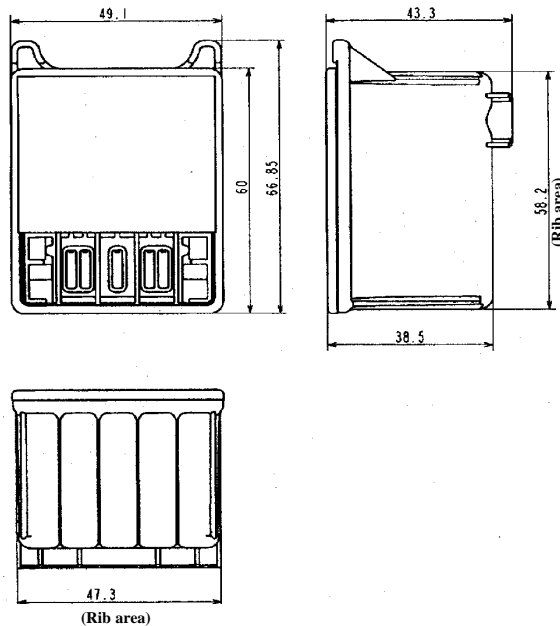

Figure 1-6. Color ink cartridge

Note 1: Ink cartridge can not re-fill, only ink cartridge is prepared for article of consumption.

Note 2: Do not use the ink cartridge which was passed away the ink life.

Note 3: Ink will be frozen under -18 ~ -21 °C environment, however it will be usable after placing it more than 3 hours at room temperature.

1.2.7 Electric Specification

[120V Version]

- Rated Voltage : AC120V
- Input Voltage Range : AC90~132V
- Rated Frequency Range : 50~ 60Hz
- Input Frequency Range : 49.5~ 60.5Hz
- Rated Current : 0.4A
- Power Consumption : Approx. 17W (ISO10561 Letter Pattern)
Approx. 4W in standby mode
Energy Star compliant
- Insulation Resistance : 100M ohms min.
(between AC line and chassis, DC 500V)
- Dielectric Strength : AC 1000V rms. 1 minute or
AC 1200V rms. 1 second
(between AC line and chassis)

[220 ~ 240V Version]

- Rated Voltage : AC220V~240V
- Input Voltage Range : AC198~264V
- Rated Frequency Range : 50~60Hz
- Input Frequency Range : 49.5~60.5Hz
- Rated Current : 0.2 A
- Power Consumption : Approx. 17W (ISO10561 Letter Pattern)
Approx. 4.5W in standby mode
Energy Star compliant
- Insulation Resistance : 100M ohms min.
(between AC line and chassis, DC 500V)
- Dielectric Strength : AC 1500V rms. 1 minute
(between AC line and chassis)

1.2.8 Environmental Condition

- Temperature
 - Operating : 10 to 35°C (refer to Figure 1-7)
 - Non-operating : -20 to 60°C (with shipment container)
1 month at 40°C and 120 hours at 60°C
- Humidity
 - Operating : 20 to 80% RH
(without condensation / refer to Figure 1-7)
 - Non-operating : 5 to 85% RH
(without condensation / with shipment container)
- Resistance to Shock
 - Operating : 1G, within 1 ms
 - Non-operating : 2G, within 2 ms (with shipment container)
- Resistance to Vibration
 - Operating : 0.15G
 - Non-operating : 0.50G (with shipment container)

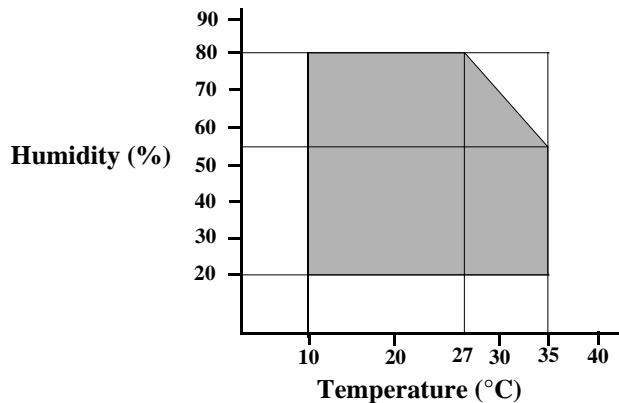

Figure 1-7. Temperature/Humidity range

1.2.9 Reliability

- Total Print Volume : 16,000 pages (A4, Letter)
or 5 years although less than 16,000 pages printing
- Print Head Life : 3 billion dots/nozzle

1.2.10 Safety Approvals

[120V Version]

- Safety Standards : UL1950
CSA22.2 No.950
- EMI : FCC part15 subpart B Class B
CSA C108.8 Class B

[220~240V Version]

- Safety Standards: : EN60950 (VDE)
- EMI : EN55022 (CISPR Pub.22) Class B
AS/NZS 3548 Class B

1.2.11 Acoustic Noise

- Level : Approx. 45dB(A) (According to ISO 7779)

1.2.12 CE Marking

[220~240V Version]

- Low Voltage Directive 73/23/EEC : EN60950
- EMC Directive 89/336/EEC : EN55022 Class B
EN61000-3-2
EN61000-3-3
EN50082-1
IEC801-2
IEC801-3
IEC801-4

1.3 INTERFACE

The EPSON Stylus PHOTO 810/820 provides USB and parallel interface as standard.

1.3.1 Parallel Interface (Forward Channel)

- Transmission Mode : 8 bit parallel, IEEE-1284 compatibility mode
- Synchronization : By STROBE pulse
- Handshaking : BY BUSY and ACKNLG signal
- Signal Level : TTL compatible level
- Adaptable Connector : 57-30360 (amphenol) or equivalent

BUSY signal is set high before setting either -ERROR low or PE high, and held high until all these signals return to their inactive state.

BUSY signal is at high level in the following cases.

- During data entry (see data transmission timing)
- When input data buffer is full
- During -INIT signal is at low level or during hardware initialization
- During printer error (see -ERROR signal)
- When the parallel interface is not selected

ERROR signal is at low level when the printer is in one of the following states.

- Printer hardware error (fatal error)
- Paper-out error
- Paper-jam error
- Ink-out error
- No ink-cartridge
- Maintenance request

PE signal is at high level during paper-out error.

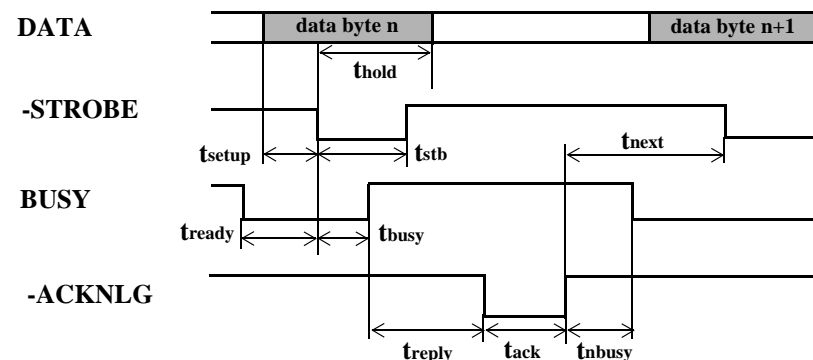

Figure 1-8. Data transmission timing

Table 1-9. Data transmission timing

Parameter	Minimum	Maximum
tsetup	500ns	-
thold	500ns	-
tstb	500ns	-
tready	0	-
tbusy	-	500ns
tt-out*	-	120ns
tt-in**	-	200ns
treply	0	-
tack	500ns	10us
tdbusy	0	-
tnext	0	-

* Rise and fall time of every output signals

** Rise and fall time of every input signals

*** Typical timing of tack is shown on the following page.

Table 1-10. Typical time of tack

Parallel I/F mode	Typical time of tack
High Speed	0.5us
Normal Speed	2us

Table 1-12. Connector pin assignment and signals

Pin No.	Signal name	Return GND pin	In/Out	Functional description
1	-STROBE	19	In	The strobe pulse. Read-in of data is performed at the falling edge of this pulse.
2	DATA0	20	In	The DATA0 through DATA7 signals represent data bits 0 to 7, respectively. Each signal is at high level when data is logical 1 and low level when data is logical 0.
3	DATA1	21	In	
4	DATA2	22	In	
5	DATA3	23	In	
6	DATA4	24	In	
7	DATA5	25	In	
8	DATA6	26	In	
9	DATA7	27	In	
10	-ACKNLG	28	Out	This signal is a negative pulse indicating that the printer can accept data again.
11	BUSY	29	Out	A high signal indicates that the printer cannot receive data.
12	PE	28	Out	A high signal indicates paper-out error.
13	SLCT	28	Out	Always at high level when the printer is powered on.
14	-AFXT	30	In	Not used.
31	-INIT	30	In	The falling edge of a negative pulse or a low signal on this line causes the printer to initialize. Minimum 50us pulse is necessary.
32	-ERROR	29	Out	A low signal indicates printer error condition.
36	-SLIN	30	In	Not used.
18	Logic H	-	Out	Pulled up to +5V via 3.9 K ohm resistor.

Table 1-11. Signal level: TTL compatible (IEEE-1284 level 1 device)

Parameter	Minimum	Maximum	Condition
VOH*	-	5.5V	
VOL*	-0.5V	-	
IOH*	-	0.32mA	VOH = 2.4V
IOL*	-	12mA	VOL = 0.4V
CO	-	50pF	
VIH	-	2.0V	
VIL	0.8V	-	
IIH	-	0.32mA	VIH = 2.0V
IIL	-	12mA	VIL = 0.8V
CI	-	50pF	

* A low logic level on the Logic H signal is 2.0V or less when the printer is powered off and this signal is equal or exceeding 3.0V when the printer is powered on. The receiver shall provide an impedance equivalent to 7.5K ohm to ground.

Table 1-12. Connector pin assignment and signals (continued)

Pin No.	Signal name	Return GND pin	In/Out	Functional description
35	+5V	-	Out	Pulled up to +5V via 3.3K ohm resistor.
17	Chassis GND	-	-	Chassis GND.
16,33, 19-30	GND	-	-	Signal GND.
15,34	NC	-	-	Not connected.

NOTE: In/Out refers to the direction of signal flow from the printer's point of view.

1.3.2 Parallel Interface (Reserve Channel)

- Transmission Mode : IEEE-1284 nibble mode
- Adaptable Connector : See forward channel
- Synchronization : Refer to the IEEE-1284 specification
- Handshaking : Refer to the IEEE-1284 specification
- Data Trans. Timing : Refer to the IEEE-1284 specification
- Signal Level : IEEE-1284 level 1 device
See forward channel.

Table 1-13. Connector pin assignment and signals

Pin No.	Signal name	Return GND pin	In/Out	Functional description
1	HostClk	19	In	Host clock signal.
2	DATA0	20	In	The DATA0 through DATA7 signals represent data bits 0 to 7, respectively. Each signal is at high level when data is logical 1 and low level when data is logical 0. These signals are used to transfer the 1284 extensibility request values to the printer.
3	DATA1	21	In	
4	DATA2	22	In	
5	DATA3	23	In	
6	DATA4	24	In	
7	DATA5	25	In	
8	DATA6	26	In	
9	DATA7	27	In	
10	PtrClk	28	Out	Printer clock signal.
11	PtrBusy / DataBit-3,7	29	Out	Printer busy signal and reverse channel transfer data bit 3 or 7.
12	AckDataReq / DataBit-2,6	28	Out	Acknowledge data request signal and reverse channel transfer data bit 2 or 6.
13	Xflag / DataBit-1,5	28	Out	X-flag signal and reverse channel transfer data bit 1 or 5.
14	HostBusy	30	In	Host busy signal.
31	-INIT	30	In	Not used.

Table 1-13. Connector pin assignment and signals (continued)

Pin No.	Signal name	Return GND pin	In/Out	Functional description
32	-DataAvail / DataBit-0,4	29	Out	Data available signal and reverse channel transfer data bit 0 or 4.
36	1284-Active	30	In	1284 active signal.
18	Logic-H	-	Out	Pulled up to +5V via 3.9K ohm resistor.
35	+5V	-	Out	Pulled up to +5V via 3.3K ohm resistor.
17	Chassis GND	-	-	Chassis GND.
16,33, 19-30	GND	-	-	Signal GND.
15,34	NC	-	-	Not connected.

NOTE: In/Out refers to the direction of signal flow from the printer's point of view.

Extensibility Request:

The printer responds affirmatively when the extensibility request values are 00H or 04H, that means,

00H : Request nibble mode reverse channel transfer.

04H : Request device ID;
Return data using nibble mode rev channel transfer.

❑ Device ID:

The printer sends the following device ID string when it is requested.

When IEEE1284.4 is enabled,

For EAI spec
 [00H] [5AH]
 MFG : EPSON;
 CMD : ESCPL2, BDC, D4;
 MDL : Stylus[SP]Photo[SP]820;
 CLS : PRINTER;
 DES : EPSON[SP]Stylus[SP]Photo[SP]820;
 For EURO/ASIA spec
 [00H] [5AH]
 MFG : EPSON;
 CMD : ESCPL2, BDC, D4;
 MDL : Stylus[SP]Photo[SP]810;
 CLS : PRINTER;
 DES : EPSON[SP]Stylus[SP]Photo[SP]810;

When IEEE1284.4 is disabled,

For EAI spec
 [00H] [57H]
 MFG : EPSON;
 CMD : ESCPL2, BDC;
 MDL : Stylus[SP]Photo[SP]820;
 CLS : PRINTER;
 DES : EPSON[SP]Stylus[SP]Photo[SP]820;
 For EURO/ASIA spec
 [00H] [57H]
 MFG : EPSON;
 CMD : ESCPL2, BDC;
 MDL : Stylus[SP]Photo[SP]810;
 CLS : PRINTER;
 DES : EPSON[SP]Stylus[SP]Photo[SP]810;

Note 1: [00H] denotes a hexadecimal value of zero.

Note2: MDL value depends on the EEPROM setting.

Note3: CMD value depends on the IEEE1284.4 setting.

1.3.3 USB Interface

- ❑ Standard : Based on
 “Universal Serial Bus Specifications Rev. 1.1”
 “Universal Serial Bus Device Class Definition for Printing Devices Version 1.1”
- ❑ Bit Rate : 12Mbps (Full Speed Device)
- ❑ Data Encoding : NRZI
- ❑ Adaptable Connector : USB Series B
- ❑ Recommended Cable Length : 2 meters

Table 1-14. Connector pin assignment and signals

Pin No.	Signal name	I/O	Function description
1	VCC	-	Cable power. Max. power consumption is 2mA.
2	-Data	Bi-D	Data
3	+Data	Bi-D	Data, pull up to +3.3V via 1.5K ohm resistor.
4	Ground	-	Cable ground

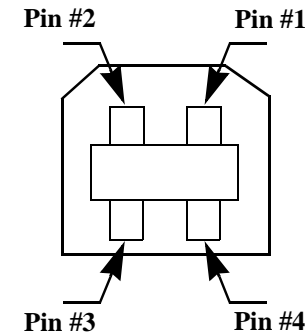

Figure 1-9. USB pin Assignment

1.3.4 Prevention Hosts of Data Transfer Time-out

Generally, hosts abandon data transfer to peripherals when a peripheral is in the busy state for dozens of seconds continuously. To prevent hosts of time-out, the printer receives data very slowly, several bytes per minute, even if the printer is in busy state. This slowdown is started when the remaining input buffer becomes several hundreds of bytes, and the printer is finally in the busy state continuously when the input buffer is full.

USB and IEEE1284.4 on the parallel interface do not require this function.

1.3.5 Interface Selection

The printer has two built-in interfaces : the USB and parallel interface.

These interfaces are selected automatically.

Automatic Selection

In this automatic interface selection mode, the printer is initialized to the idle state scanning which interface receives data when it is powered on. Then the interface which receives data first is selected. When the host stops data transfer and the printer is in the stand-by state for seconds, the printer is returned to the idle state. As long as the host sends data or the printer interface is in busy state, the selected interface is let as it is.

Interface State and Interface Selection

When the parallel interface is not selected, the interface gets into the busy state. When the printer is initialized or returned to the idle state, the parallel interface gets into the ready state. Caution that the interrupt signal such as the -INIT signal on the parallel interface is not effective while that interface is not selected.

1.3.6 IEEE1284.4 Protocol

The packet protocol described by IEEE1284.4 standard allows a device to carry on multiple exchanges or conversations which contain data and/or control information with another device at the same time across a single point-to-point link. The protocol is not, however, a device control language. It provides basic transport-level flow control and multiplexing services. The multiplexed logical channels are independent of each other and blocking of one has no effect on the others. The protocol operates over IEEE1284.

Automatic Selection

An initial state is compatible interface and starts IEEE1284.4 communication when magic strings (1284.4 synchronous commands) are received.

On

An initial state is IEEE1284.4 communication and data that received it by the time it is able to take synchronization by magic string (1284.4 synchronous commands) is discarded.

Off

An initial state is compatible interface and never starts IEEE1284.4 communication even if magic strings (1284.4 synchronous commands) are received.

1.4 PANEL CONTROL

The control panel of the EPSON Stylus PHOTO 810/820 is composed of the 2 non-lock type push-buttons, 1 lock-type push-button, and 2 LEDs, as shown figure below.

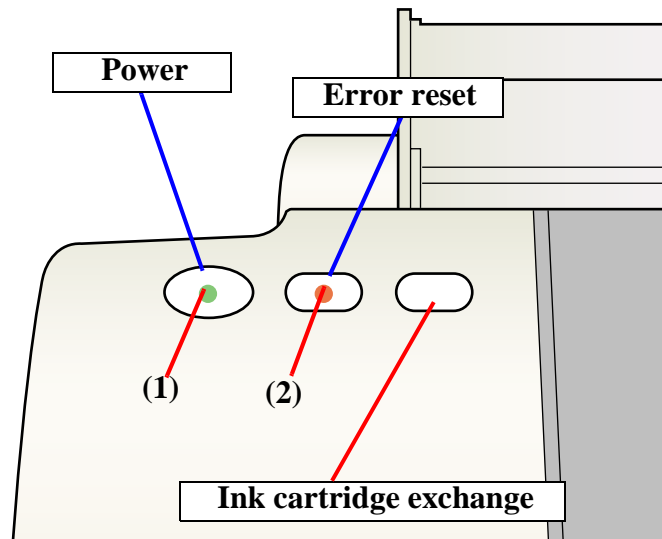

Figure 1-10. Control panel

1.4.1 Indicators (LEDs)

- (1) **Power**
Lights when the operating switch is “ON” and AC power is supplied.
- (2) **Error**
Lights or blinks when some error has occurred on the printer.

1.4.2 Panel Functions

Table 1-15. Panel functions

Switch	Function
Error reset SW	<ul style="list-style-type: none"> • Loads or Ejects the Paper (Pushing within 3seconds). • Starts the Cleaning of head (Pushing for 3seconds). • When carriage is on the Ink Cartridge change position, return carriage from Ink cartridge change position.
Ink cartridge exchange SW	<ul style="list-style-type: none"> • Starts the Ink Cartridge change sequence. *

* This function is not available in printing status.

Table 1-16. Panel functions with power on

Switch	Function
Error reset SW	<ul style="list-style-type: none"> • Start status printings.
Ink cartridge exchange SW	<ul style="list-style-type: none"> • Selects IEEE 1284.4 mode for parallel I/F. *1

*1 Not described in the user's manual.

1.4.3 Printer Condition and Panel Status

Table 1-17. Printer condition and LED status

Printer status	Indicators		Priority
	Power	Error	
Power ON condition	On	-	10
Ink sequence	Blink	-	6
Ink cartridge change mode	Blink	-	5
Data processing	Blink	-	9
Paper out *1	-	On	4
Paper jam condition *1	-	On	3
Ink end (Black) *1	-	On -> Blink	8
Ink level low (Black)	-	Blink-> Blink	8
Ink end (Color) *1	-	On -> Blink2	8
Ink level low (Color)	-	Blink-> Blink2	8
Ink end (Black and Color)	-	On -> On	8
No ink cartridge (Black and Color) *1	-	On	7
Maintenance request (Ink overflow counter error) *1	Alt Blink	Alt Blink	2
Fatal error *1	Off	On	1
Special setting	Blink2	Blink2	-

" - " : Indicator status don't change.

" A -> B " : A is a indicator condition when carriage is in Home Position.

B is a indicator condition in Ink exchange sequence.

*1: refer to 1.4.4 "Error Status" or detailed information.

Blink : On 0.5sec + Off 0.5sec

Blink2 : On 0.2sec + Off 0.2sec + On 0.2sec + Off 0.4sec

1.4.4 Error Status

- ❑ **Ink end error**
When the printer runs out the most amount of the ink of any one color, it indicates ink low and keeps printing. When the printer runs out the whole ink of any color, it stops printing and indicates ink end error. User is then requested to install a new ink cartridge in this state.
- ❑ **Paper out error**
When the printer fails to load a sheet, it goes into a paper out error.
- ❑ **Paper jam error**
When the printer fails to eject a sheet, it goes into a paper jam error.
- ❑ **No ink cartridge**
When the printer detects that ink cartridge comes off, or failed to read or write CSIC data, it goes into this error mode.
- ❑ **Maintenance request**
When the total amount of ink wasted through cleanings and flushing reaches to the limit, printer indicates this error and stops. In such a case, the absorber in the printer enclosure needs to be replaced with new one by a service person.
- ❑ **Fatal error**
Carriage control error.

1.4.5 Printer Initialization

There are four kinds of initialization method, and the following explains each initialization.

1. **Power-on initialization**
This printer is initialized when turning the printer power on, or printer recognized the cold-reset command (remote RS command).
When printer is initialized, the following actions are performed.
 - (a) Initializes printer mechanism
 - (b) Clears input data buffer
 - (c) Clears print buffer
 - (d) Sets default values
2. **Operator initialization**
This printer is initialized when turning the printer power on again within 10 seconds from last power off, or printer recognized the -INIT signal (negative pulse) of parallel interface.
When printer is initialized, the following actions are performed.
 - (a) Cap the printer head
 - (b) Eject a paper
 - (c) Clears input data buffer
 - (d) Clears print buffer
 - (e) Sets default values
3. **Software initialization**
The ESC@ command also initialize the printer.
When printer is initialized, the following actions are performed.
 - (a) Clears print buffer
 - (b) Sets default values
4. **Power-on initialization except I/F**
The printer recognized the IEEE 1284.4 "rs" command.
When printer is initialized, the following action is performed.
 - (a) Initializes printer mechanism
 - (b) Clears input data buffer
 - (c) Clears print buffer
 - (d) Sets default values except I/F

CHAPTER

2

OPERATING PRINCIPLES

2.1 Overview

This section describes the operating principles of the Printer mechanism and electrical circuit boards. Like the previous printers (Stylus COLOR 480/580), the Stylus PHOTO 810/820 has only the following two circuit boards and does not have the control panel board.*1

- Main board : C418 Main/Main-B board *2
- Power supply board : C417 PSB/PSE board

*1 : Due to this, the Stylus COLOR 480/580 does not have switches (Power, Error reset, Ink cartridge replacement) and LEDs. However, the Stylus PHOTO 810/820 has them on the C418 Main board instead of the control panel board.

*2 : C418 Main/Main-B board is used for the Stylus C60 and Stylus Photo 810/820. However, there is difference of ASIC & PROM mounted on the C418 Main board between the Stylus C60 and the Stylus Photo 810/820.

2.1.1 Printer Mechanism

The Printer mechanism for the Stylus PHOTO 810/820 is newly designed. But, the basic component of the Printer mechanism is almost the same as the previous printer (Stylus COLOR 480/580).

This printer consists of Printhead, Carriage mechanism, Paper loading mechanism, Paper feeding mechanism, Ink system (Pump mechanism including newly designed Carriage lock mechanism, Capping mechanism including newly designed Wiper mechanism).

Like the previous printers (Stylus COLOR 480/580), the Stylus PHOTO 810/820 is equipped with two stepping motors; one for the Paper loading/feeding mechanism and the Pump mechanism with the CR lock mechanism, and one for the CR mechanism. The ASF unit for the Paper loading mechanism uses rear entry front eject system. And, single LD roller in Holder shaft unit loads a paper to the Printer mechanism.

The Cap unit which adopts the valveless mechanism is newly designed on this printer as follows.

- No porous pad in cap
- Cap unit with wiper

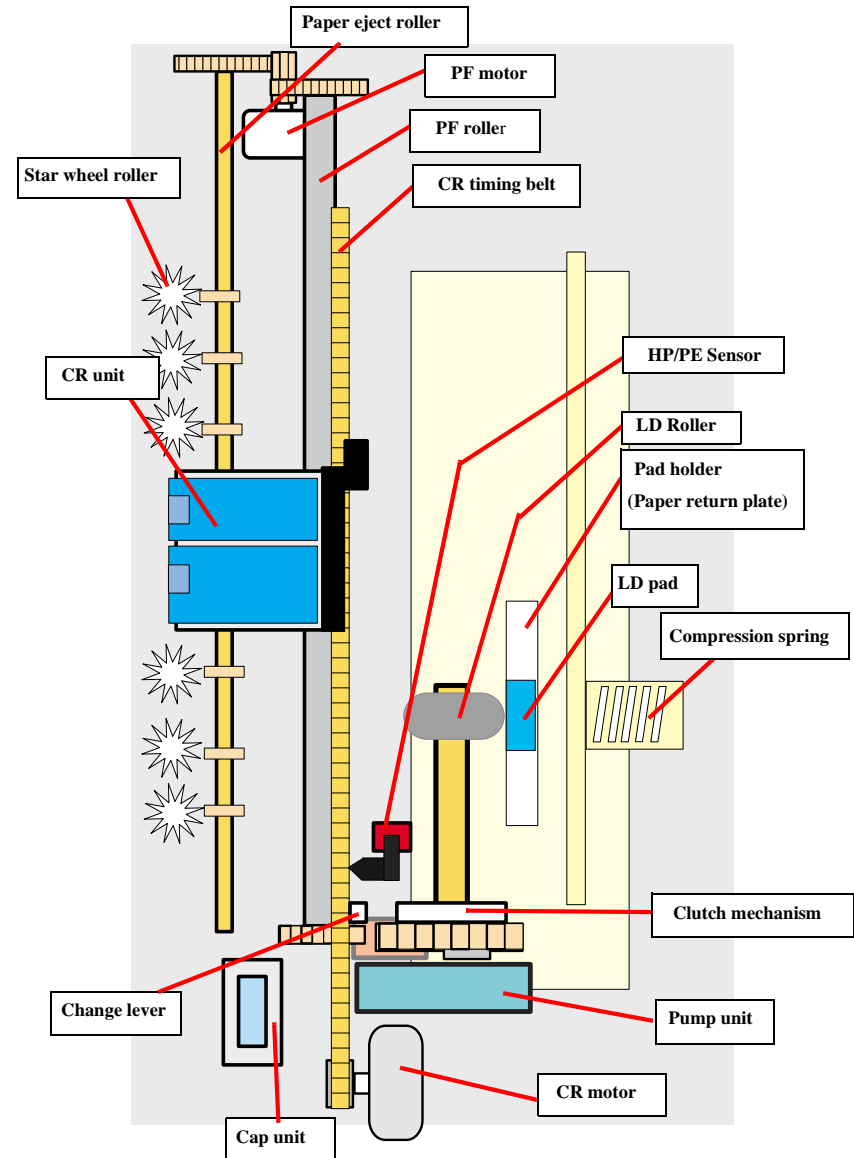

Figure 2-1. Printer mechanism block diagram

2.1.2 Printhead

The Printhead uses the same U-CHIPS type as the previous printer (Stylus COLOR 680), and makes it possible to perform multiple shot printing and variable dot printing.

The Printhead nozzle configuration is as follows.

- Nozzle layout
 - Black: 48 nozzles x 1 row (nozzle pitch of row: 1/120 inch)
 - Color: 48 nozzles x 1 row/co₂ (nozzle pitch of row: 1/120 inch)

The nozzle layout when viewed from the back surface of the Printhead is shown below.

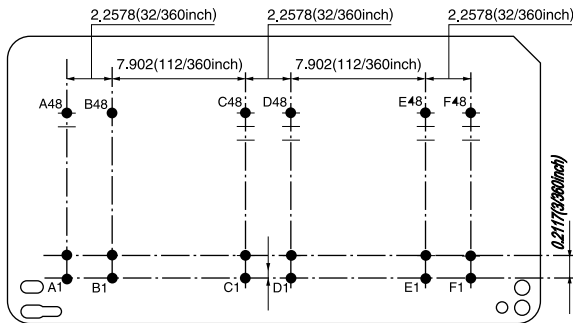

Figure 2-2. Nozzle layout

The Printhead has the electric poles to store the ink consumption amount data into the CSIC chip mounted on the ink cartridge. By storing the ink consumption amount data, this printer can detect the ink consumption status, such as ink low/end condition.

The basic operating principles of the Printhead, which plays a major role in printing, are the same as the previous printer (Stylus COLOR 680); on-demand method which uses PZT (Piezo Electric Element). In order to uniform the ejected ink amount, the Printhead has its own Head ID (13 digits code for this Printhead) which adjusts PZT voltage drive features.

So, you are required to store the Head ID pasted on the Printhead into the EEPROM by using the Adjustment program when replacing the Printhead, the Main board, the Printer mechanism with new one. (Note : there are no resistor arrays to determine the Head ID on the Main board.) And then, based on the stored Head ID into the EEPROM, the Main board generates appropriate PZT drive voltage.

Following explains the basic components for the Printhead.

- PZT

PZT is an abbreviation of Piezo Electric Element. Based on the drive waveform generated on the Main board, the PZT selected by the nozzle selector IC on the Printhead pushes the top of the ink cavity, which has ink stored, to eject the ink from each nozzle on the nozzle plate.
- Electric poles for CSIC

This electric poles connects the CSIC chip mounted on the ink cartridge. By using this poles, current ink consumption amount data is read out from the CSIC chip. And, the latest ink consumption amount data is written into the CSIC chip.
- Nozzle Plate

The plate with nozzle holes on the Printhead surface is called Nozzle Plate.
- Filter

When the ink cartridge is installed, if any dirt or dust around the cartridge needle is absorbed into the Printhead, there is a great possibility of causing nozzle clog and disturbance of ink flow, and alignment failure and dot missing finally. To prevent this problem, a filter is set under the cartridge needle.
- Ink Cavity

The ink absorbed from the ink cartridge goes through the filter and then is stored temporarily in this tank called “ink cavity” until PZT is driven.

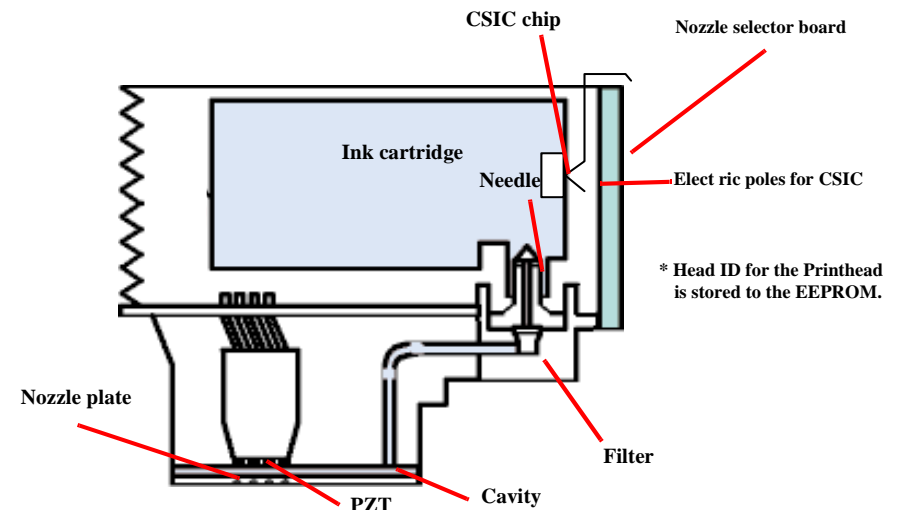

Figure 2-3. Printhead sectional drawing

2.1.2.1 Printing Process

This section explains the process which the Printheads of On-Demand inkjet printers eject ink from each nozzle.

1. Normal state :

When the printing signal is not output from C418 Main board, or the PZT drive voltage is not applied, the PZT does not change the shape. Therefore, the PZT does not push the ink cavity. The ink pressure inside the ink cavity is kept normal. (refer to Figure 2-4 : Normal state)

2. Ejecting state :

When the print signal is output from the C418 Main board, the nozzle selector IC located on the Printhead latches the data once by 1-byte unit. Based on the drive waveform (common voltage) generated on the Main board, the PZT selected by the nozzle selector IC pushes the top of the ink cavity. By this operation, the ink stored in the ink cavity is ejected from nozzles. (refer to Figure 2-4 : Ejecting state)

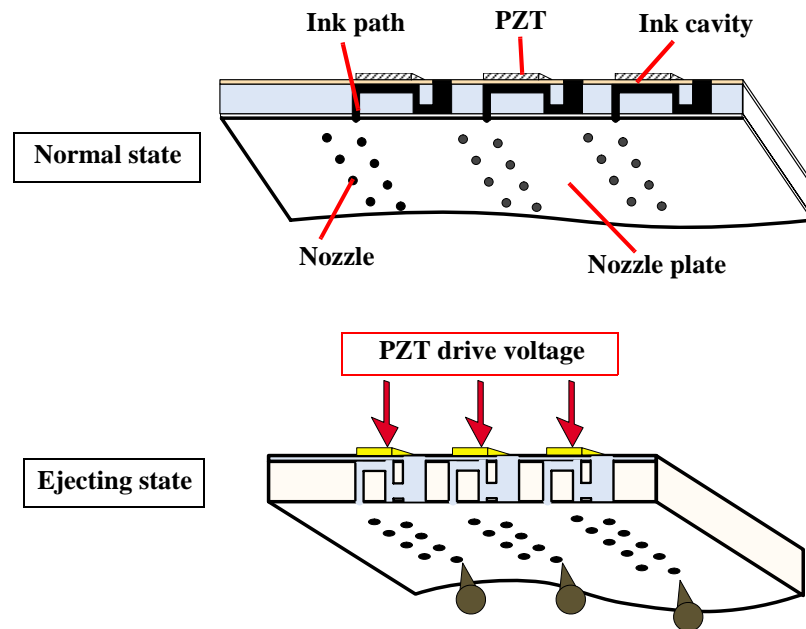

Figure 2-4. Printhead printing process

2.1.2.2 Printing Method

For printing dot system, the Stylus PHOTO 810/820 has the following two kinds of printing mode.

- Multiple shot printing
- Variable dot printing

The above two printing modes are automatically selected depending on the media and the resolution setting of the printer driver. The following explains each printing mode.

□ Multiple shot printing

This printing mode is developed to improve the print quality on plain paper or transparencies in low resolution. The multiple shot printing mode uses normal dot, and the number of dot shot varies from 1 shot to maximum 3 shots depending on the print data to enable to output sharp image even in a low resolution.

□ Variable dot printing

This printing mode is developed to improve the print quality on exclusive paper. This mode is basically the same as variable dot printing mode used on other products; micro dot, middle dot and large dot compose this mode. The printing dot size varies according to the print data and this mode enables to output even sharper image on exclusive paper.

2.1.3 Carriage Mechanism

The Carriage mechanism consists of CR motor, Carriage unit (including the Printhead and CR guide shaft), CR timing belt and CR home position sensor (HP/PE sensor) etc. Following figure shows you each component for the CR mechanism.

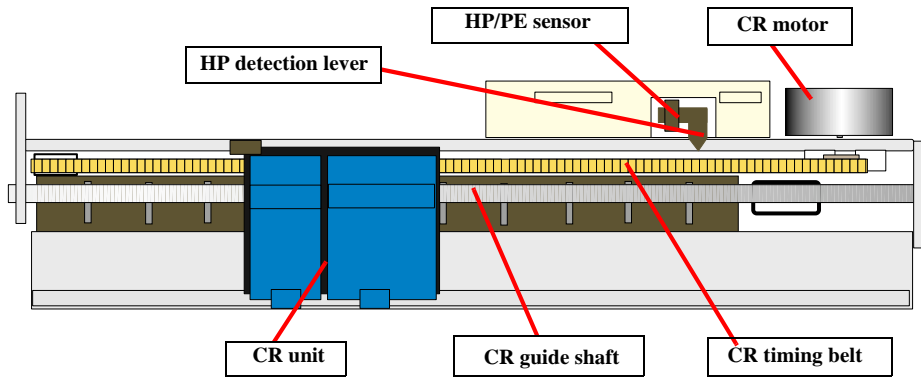

Figure 2-5. Carriage mechanism (Top view)

The following stepping motor controls the CR mechanism on this printer.

Table 2-1. Carriage motor specification

Items	Specifications
Type	4-Phase/ 200-Poles HB Stepping motor
Drive Voltage	+42 V +/- 5% (DRV IC voltage)
Coil Resistance	7.8 Ω +/- 10% (per phase at 25 degrees)
Inductance	14 mH +/- 20% (1KH 1Vrms)
Drive Method	Bi-Polar drive
Driver IC	LB1946

The drive of the CR motor is transmitted to the CR unit via the CR timing belt. And, the CR home position is detected with the HP/PE sensor. This sensor is available as the CR home position sensor while the CR motor operates in each sequence. (The function of this sensor varies depending on the running condition of the motors. It is available as the PE sensor when the PF motor operates in each sequence.)

When the detection plate molded on the CR unit pushes down the HP detection lever and the CR home position is detected with HP/PE sensor, HIGH signal is output to the CPU.

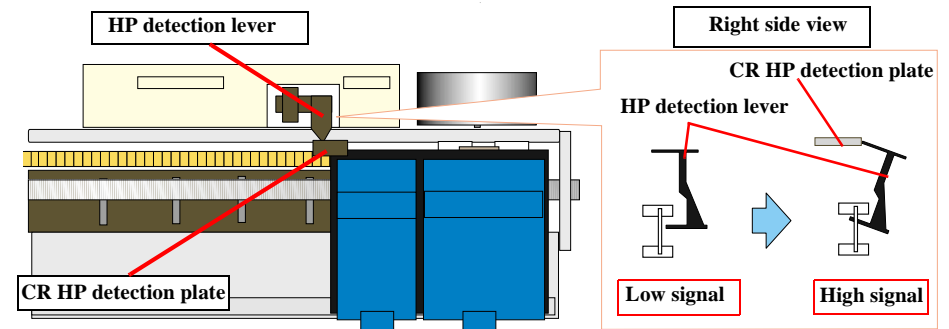

Figure 2-6. CR home position detection

Moreover, like the previous printers (Stylus COLOR 480/580), this printer does not also have the PG adjustment mechanism. Therefore, the CR guide shaft is assembled with the defined PG value (1.7 ± 0.2 mm).

For your reference, in case that the CR home position is not detected with the HP/PE sensor although the CR unit moves correctly, the printer indicates the "Fatal error". And also, in case that the CR unit cannot move outside the home position and the CR home position is not detected with the HP/PE sensor, the printer indicates the "Paper jam error".

2.1.4 Paper Loading/Feeding Mechanism

The following stepping motor controls the Paper loading/feeding mechanism on this printer.

Table 2-2. PF motor specifications

Item	Description
Motor type	4-Phase/ 96-Poles PM Stepping motor
Drive voltage	+42 V +/- 5% (DRV IC voltage)
Coil Resistance	6 Ω +/- 10% (per phase at 25 degrees)
Inductance	9.5 mH +/- 20% (1kHz 1Vrms)
Driving method	Bi-Polar drive
Driver IC	LB1946

The drive of the PF motor is transmitted to the LD roller shaft and the PF roller through gears for the Paper loading/feeding mechanism. The Paper loading mechanism plays a role in loading a paper from the ASF unit to the PF roller. And also, the Paper feeding mechanism plays a role in feeding a paper loaded from the ASF unit. The functions of the Paper loading/feeding mechanism varies depending on the rotational direction of the PF motor as the table below.

Table 2-3. ASF unit function & PF motor rotational direction

Directions ^{*2}	Corresponding functions
Clockwise	<ul style="list-style-type: none"> Release the Change lever from the Clutch mechanism
Counterclockwise	<ul style="list-style-type: none"> Pick up and feed a paper Set the Change lever on the Clutch mechanism

^{*2} : The PF motor rotation direction = seen from the left side of the printer.

Following shows you the transmission path of the PF motor drive to the LD roller, the PF roller and the Paper eject roller. (The numbers in the following figure show you the order of transmission path.)

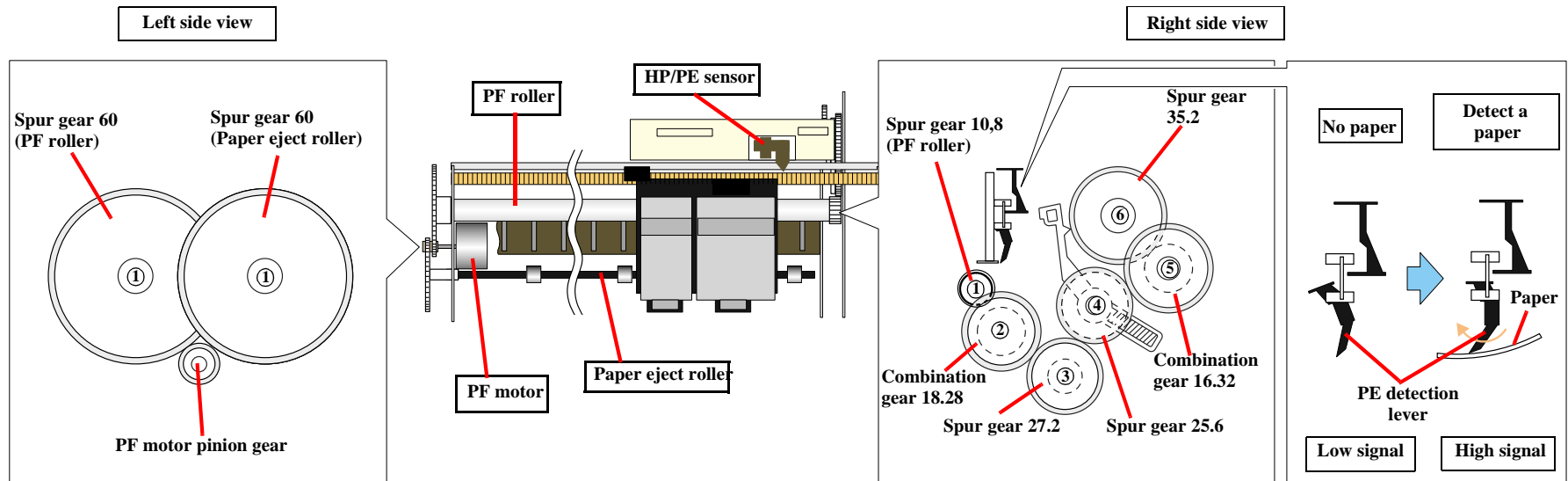

Note: The Clutch gear is molded on the backside of the Spur gear 35.2 such as Combination gear.

Figure 2-7. Paper loading/feeding mechanism

For your reference, the top or the end of a paper is usually detected with the HP/PE sensor. In case that the HP/PE sensor cannot detect the top of a paper in the paper loading sequence, the printer indicates the "Paper out error". If the HP/PE sensor cannot detect the end of a paper in the paper feeding sequence, the printer indicates the "Paper jam error". As for the details, refer to Chapter 3 "Troubleshooting".

2.1.4.1 Paper Loading Mechanism (ASF unit)

The Paper loading mechanism consists of the Change lever in the Pump unit, the Holder shaft unit (including the Clutch mechanism) and the ASF unit.

The Change lever and the Clutch mechanism play a major role in the Paper loading mechanism as follows.

1. ASF home position detection function

The ASF unit on this printer does not have the ASF home position sensor. Instead of the ASF home position sensor, the Change lever and the Clutch mechanism is used to detect the ASF home position.

When the Change lever is set on the Clutch mechanism with the counterclockwise rotation of the PF motor pinion gear, the ASF home position is detected by this lever for the paper loading operation. In this time, the printer cannot load a paper from ASF unit because the drive of the PF motor is not transmitted to the LD roller shaft.

2. Paper loading function

When the Change lever is released from the Clutch mechanism with the clockwise rotation of the PF motor pinion gear, the ASF home position detection function is changed over to the paper loading function. Therefore, the printer can load a paper from ASF unit because the drive of the PF motor is transmitted to LD roller shaft.

On this printer, the Paper return plate is built in ASF unit instead of the Paper return lever. The LD pad is stacked on the Paper return plate, and it works with the tension force of the Torsion spring 29.1 mounted on the ASF frame.

When an arc portion of the LD roller pushes down this plate into the ASF frame during the paper loading sequence, a paper is loaded from the ASF unit. A cutout portion of the LD roller releases this lever and this plate returns papers to the stand-by position for next paper loading operation.

Following figures (refer to Figure 2-8/Figure 2-9) show you the ASF paper loading sequence and the operation of each mechanism.

When the PF motor pinion gear rotates CW direction (Right side view), the Change lever pushes down the Clutch lever as right figure and the Clutch lock tooth is disengaged from the Clutch gear. As the result, the LD roller shaft dose not rotate at all because the drive of the PF motor is not transmitted. In this time, the ASF hopper is also pushed down by the ASF hopper release lever on the LD roller shaft, and the Paper return plate is set to avoid that papers are slipped down from the paper set position.

This position is the ASF home position.

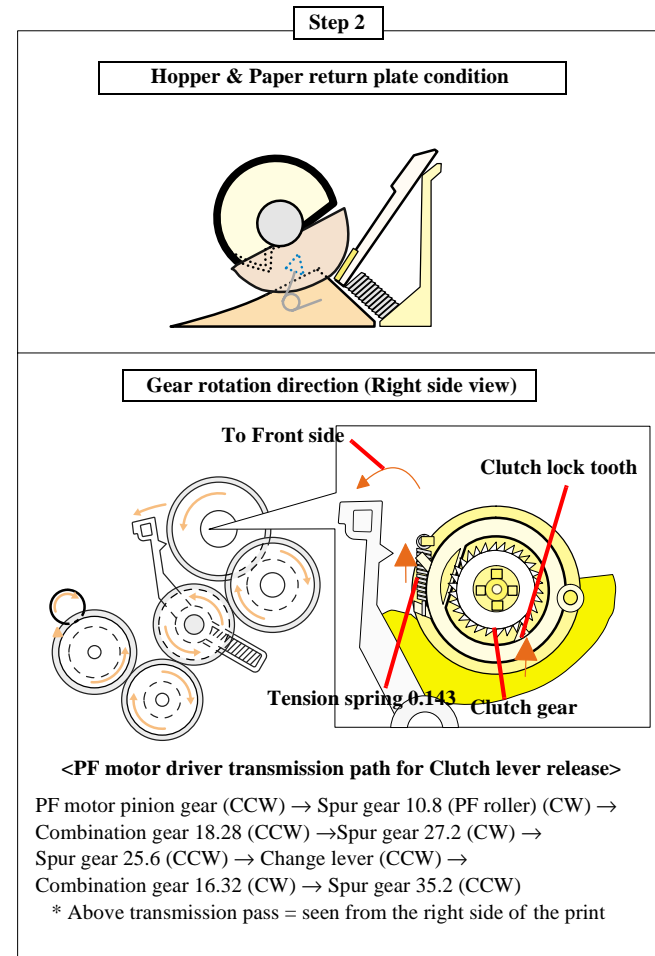
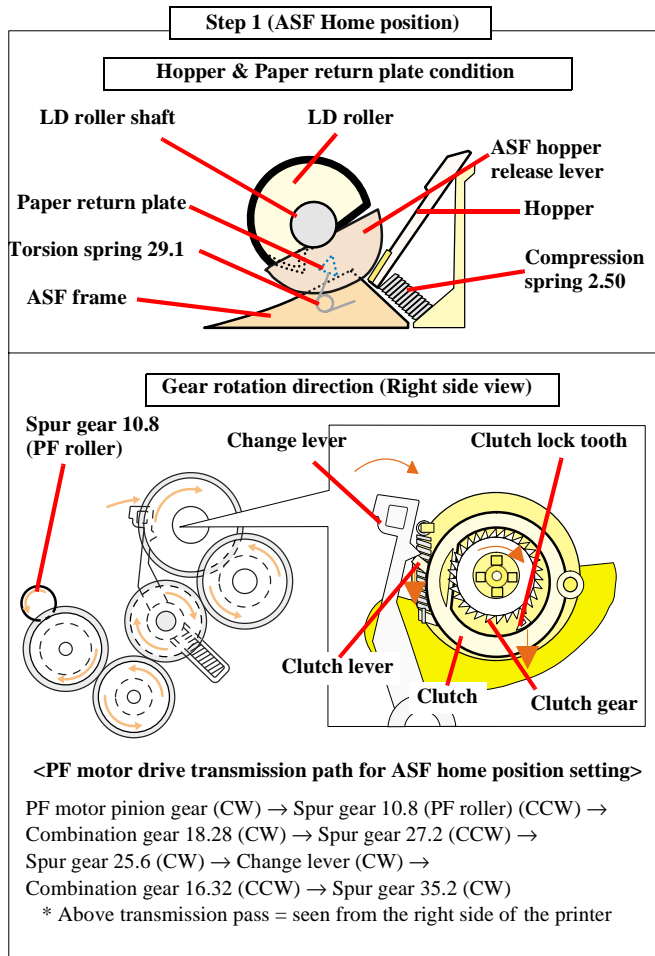

When a paper is loaded from the ASF unit, the Change lever moves to the front side of the printer with the CCW rotation (right side view) of the PF motor pinion gear and releases the Clutch lever. As the result, the Clutch turns back to the engagement position by the tension force of the Tension spring 0.143. And, the Clutch gear is engaged with the Clutch lock tooth to transmit the drive of the PF motor as left figure. In this time, the Change lever is locked instantaneously by the protrusion on the backside of the CR unit to change over from the ASF home position detection function to the paper loading function surely.

Figure 2-8. ASF paper loading sequence (Step 1, 2)

The PF motor pinion gear rotates CW direction (right side view), and the drive of the PF motor is transmitted to the LD roller shaft through the Clutch lock tooth and the Clutch gear. After the LD roller pushes down the Paper return plate into the ASF frame, the ASF hopper is released by the tension force of the Compression spring 2.50. And, a paper is picked up with the frictional force between the LD roller and the Pad hopper.

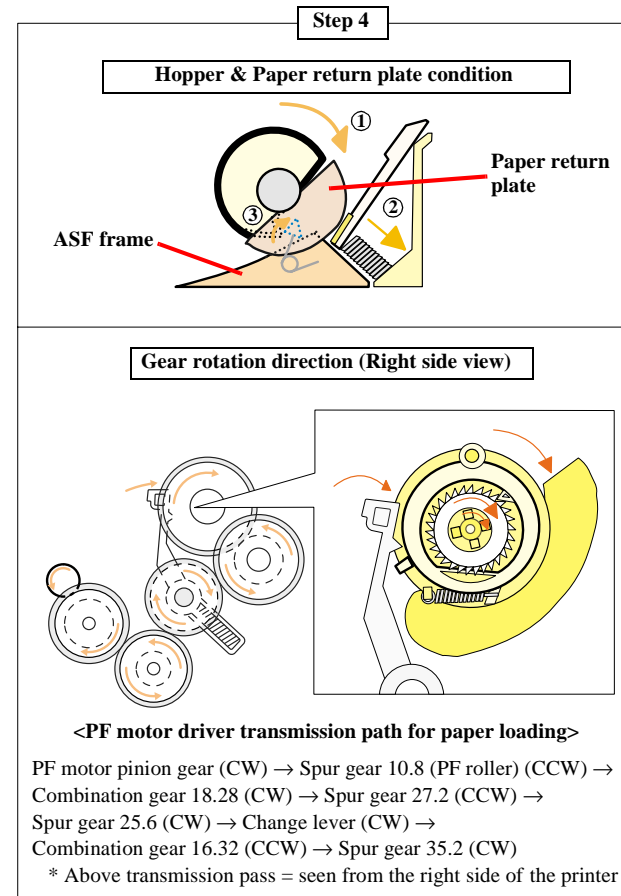
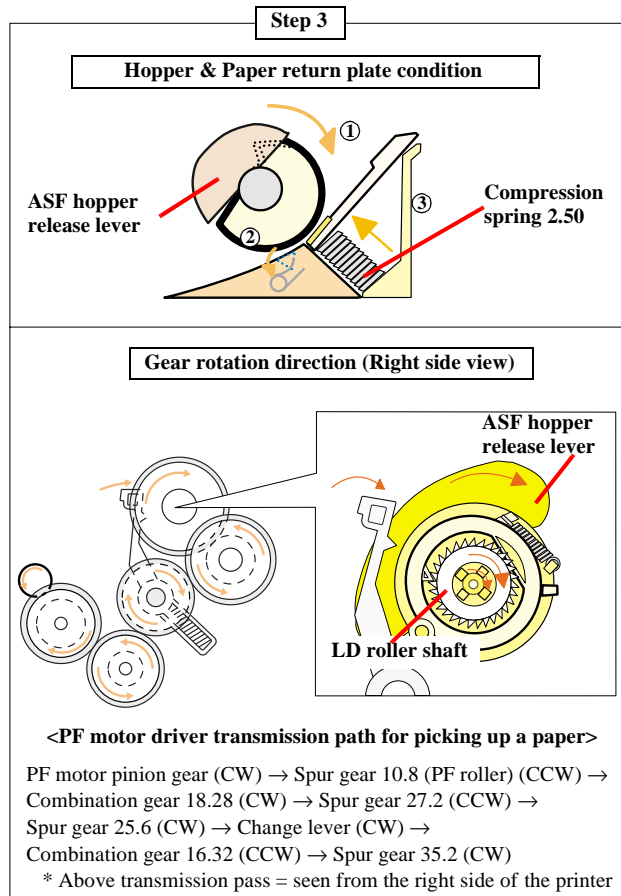

While the LD roller rotates CW direction (right side view) continuously, the top of a paper is loaded to the PF roller. In this rotation, the ASF hopper returns to the open position and the Paper return plate is released from the LD roller. In this time, this plate returns papers to the stand-by position in ASF unit for next paper loading operation.

Then, when the rolling LD roller & the Clutch come at the above "Step1" position, the Clutch lever is locked with the Change lever again. In this time, the drive of the PF motor is interrupted and the drive is transmitted only to the PF roller side for the paper feeding sequence.

Figure 2-9. ASF paper loading sequence (Step 3, 4)

2.1.4.2 Paper Feeding Mechanism

The Paper feeding mechanism consists of PF motor, PF roller, Paper eject roller^{*1}, Paper end sensor (HP/PE sensor) etc. The Paper feeding mechanism feeds a paper loaded from ASF unit by using pairs of rollers.

^{*1} : Different from the Paper eject roller for the Stylus C60, the metal shaft is used for this printer to improve the paper feeding accuracy.

1. One pair is the PF roller and the Paper guide roller which is assembled in the Paper guide upper/left. The drive of the PF motor is transmitted to the Paper guide roller through the PF roller.

2. Another pair is the Paper eject roller and the Star wheel which is assembled on the Front frame. The drive of the PF motor is transmitted to the Star wheel through the Paper eject roller.

Following figure shows you the transmission path for the PF roller & the Paper guide roller and the Paper eject roller & the Star wheel.

The top of a paper is loaded to the PF roller from the ASF unit in the paper loading sequence. And then, when the PF motor pinion gear rotates CCW direction (left side view), a paper is fed by the PF roller & the Paper guide roller and the Paper eject roller & the Star wheel in the printing operation & the paper feed sequence.

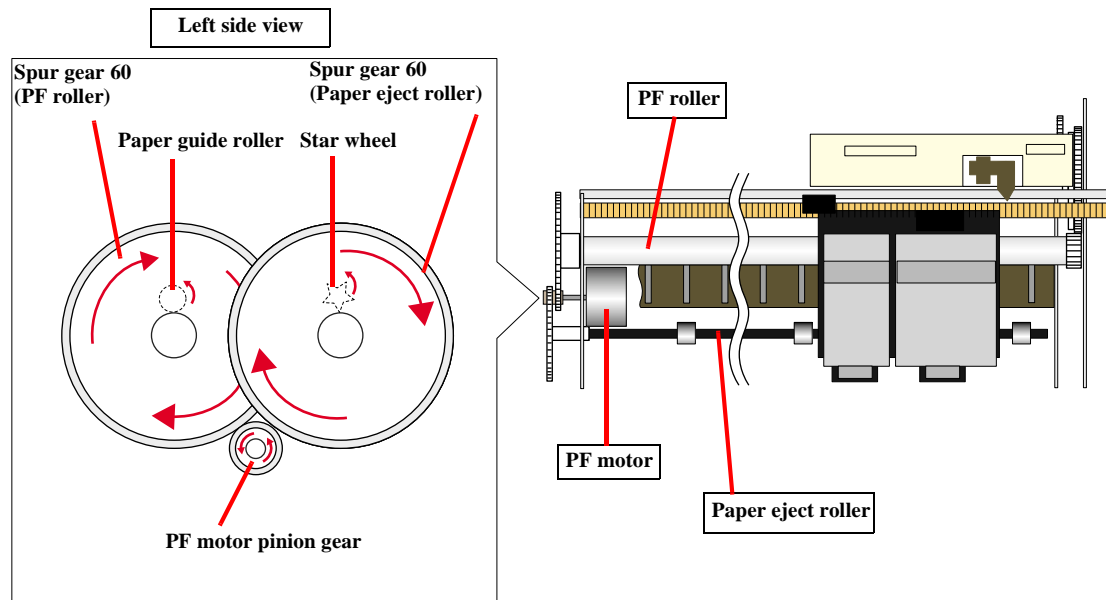

Transmission path (Left side view) : PF motor pinion gear (CCW) → Spur gear 60 (PF roller /Paper eject roller) (CW)

Figure 2-10. Paper feeding mechanism

2.1.5 Ink System Mechanism

The Ink system mechanism consists of Pump mechanism with Carriage lock mechanism and Capping mechanism with Wiper mechanism. Following table lists the function for each mechanism.

Table 2-4. Function for each mechanism

Mechanism	Function
Capping mechanism *	This is to cover the surface of the Printhead with the cap in order to prevent the nozzle from increasing viscosity.
Wiper mechanism	This is to remove the foreign material and unnecessary ink on the nozzle plate of the Printhead.
Pump mechanism	This is to eject the ink from the ink cartridge, the ink cavity and the cap to the Waste drain ink pad.
Carriage lock mechanism	This is to lock the CR unit with the Change lever while the CR unit is at the home position.

* Like the previous printers (Stylus COLOR 480/580), this printer adopts the valveless cap system. The air valve system used for the previous printer (Stylus COLOR 740) have two functions by the CR position in the capping condition as follows.

1) Valve closing condition (CL position)

By closing the air valve, the ink is forcibly absorbed from the ink cartridge or the ink cavity by the Pump unit and is ejected to the Waste drain ink pad while the CR unit is in the CL position.

2) Valve opening condition (Ink absorption position)

By opening the Air valve, the negative pressure is decreased and only the ink inside the Cap is ejected while the CR unit is in the further right side than the CL position. (the ink is not absorbed from the ink cartridge or the ink cavity.)

The following shows you the CR unit position for each condition easily.

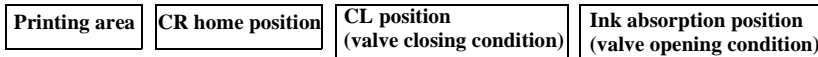

But, on the valveless cap system, the above 2) operation is done outside the capping position. The CR unit moves outside the CR home position and the pump absorbs the ink inside the Cap.

2.1.5.1 Capping Mechanism

The Capping mechanism covers the Printhead with the Cap to prevent the nozzle from increasing viscosity when the printer is in stand-by state or when the printer is off. Unlike the previous printers (Stylus COLOR 480/580), the Cap unit is newly designed for this printer as follows.

1. Non porous pad in Cap

Due to this, the cap is newly designed as follows.

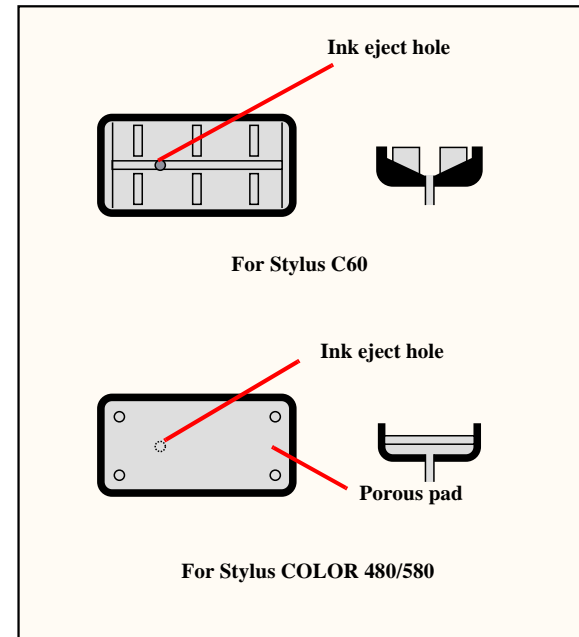

Figure 2-11. Cap mechanism

The Cap unit used for the previous printers (Stylus COLOR 480/580) has the porous pad to keep the moisture in the Cap *1 and prevent that the air bubbles occur in CL sequence*2. The following points are modified to get the same effects on new Cap unit without the porous pad.

*1 : The diameter of the ink eject hole is smaller than that of Stylus COLOR 480 /580.

*2 : The cap is modified so that the ink flows with air bubbles to the ink eject hole in the ink absorption sequence more easily.

2. Wiper with the Cap unit

The wiping operation is controlled by the CR unit movement. This operation is usually performed with every CL sequence which is to absorb the ink from the ink cartridge, the ink cavity by the Pump unit. Following figure shows you the mechanism for the wiping operation.

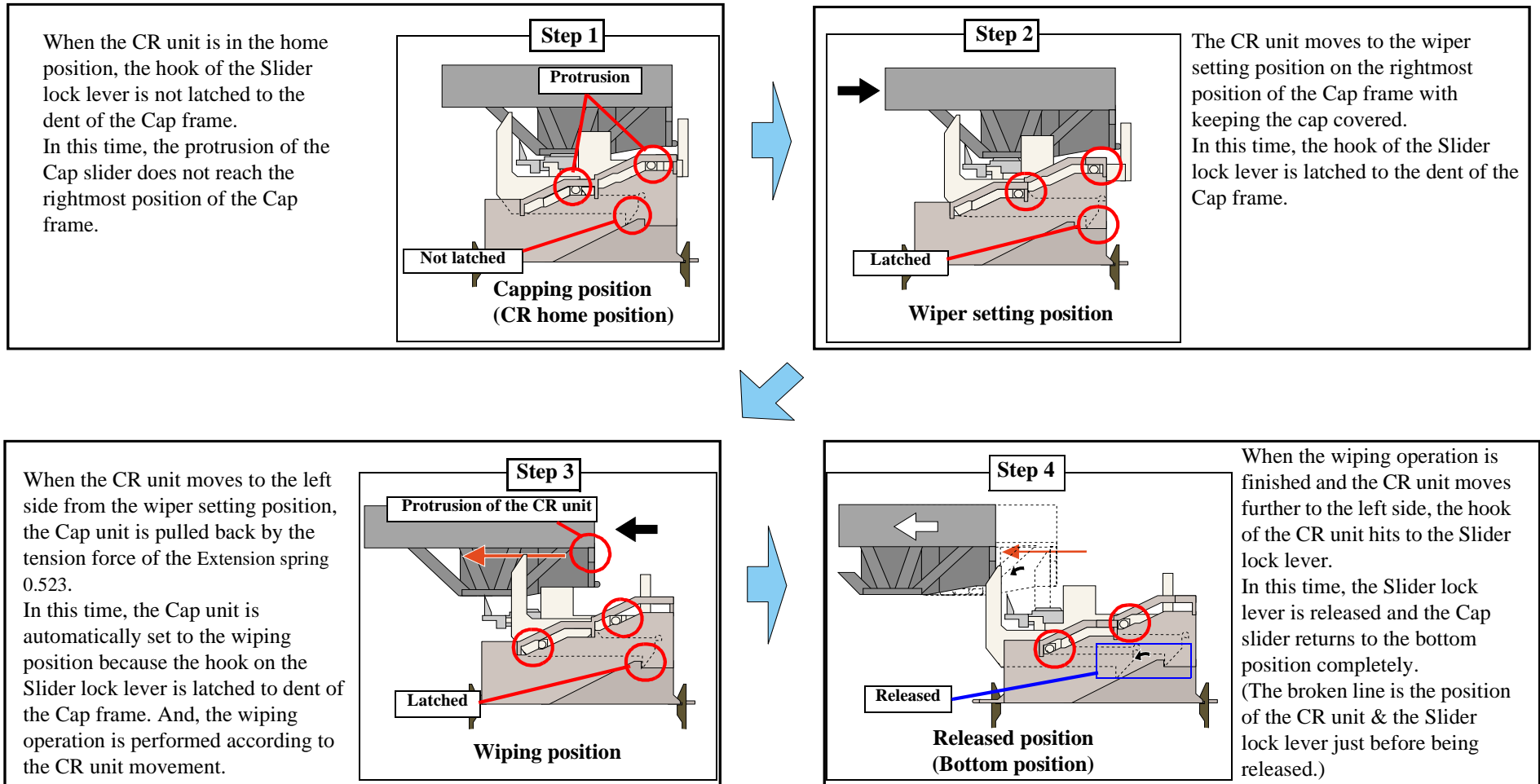

Figure 2-12. Wiper mechanism

2.1.5.2 Pump unit mechanism

The PF motor also controls the Pump unit mechanism (including the Change lever) as well as the Paper loading/feeding mechanism. The drive of the PF motor is always transmitted to the Pump unit. (And also, its drive is transmitted to the LD roller through the Clutch mechanism & the Change lever.)

On this printer, the Pump unit mechanism including the Change lever plays a major role expecting the ink eject operation. And, these operations control depending on the PF motor rotational direction as the following table below.

Table 2-5. PF motor rotational direction & Ink system mechanism

Directions (*1)	Functions
Clockwise	<ul style="list-style-type: none"> Absorbs the ink by the Pump unit Release the Change lever from the Clutch mechanism
Counterclockwise	<ul style="list-style-type: none"> Non operation

(*1): The PF motor rotational direction = seen from the left side of the printer.

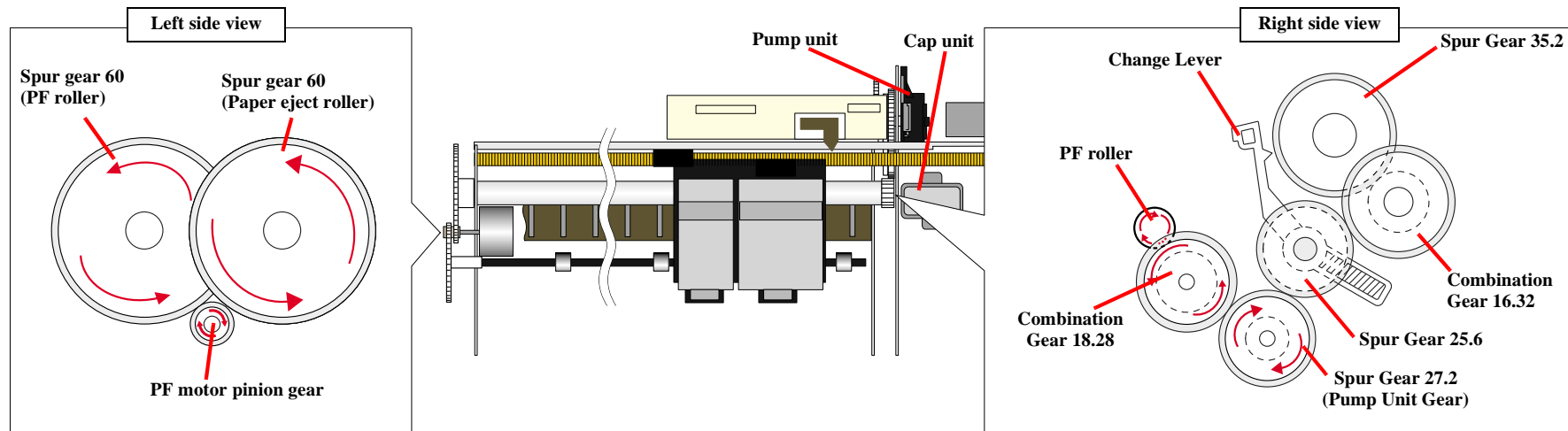

Transmission Path : PF motor pinion gear (CCW) → Spur gear 60 (PF roller & Paper eject roller) (CW) → Spur gear 10.8 (CCW) → Combination gear 18.28 (CW) → Spur gear 27.2 (Pump unit gear) (CCW)
 (* Above transmission pass = seen from the right side of the printer)

Figure 2-14. PF motor drive transmission path to the Pump unit

1. Ink eject operation (usual operation)
 The ink is absorbed from the ink cartridge, the ink cavity and is ejected to the Waste drain ink pad from the cap when the ink tube is pressed by a roller in the Pump unit.

Following figure shows you the overview of the Pump unit mechanism operation

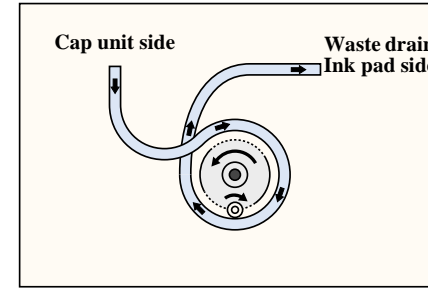

(*1): The PF motor rotational direction = seen from the right side of the printer.

Figure 2-13. Pump mechanism

2. Carriage lock operation by the Change lever
Unlike the previous printer (Stylus COLOR 680), this printer does not have the Carriage lock lever with the Wiper.
Instead of the Carriage lock lever, the Change lever is set to the front side of the printer while the CR unit is in the CR home position.
(As for the detailed mechanism for setting the Change lever, refer to Figure 2-8 Step 2)

2.1.6 Ink Sequence

- Initial ink charge
After the printer is purchased and the power is turned on for the first time, the printer must perform the initial ink charge to charge the ink inside the ink cavity. When the initial ink charge is completed properly, the printer releases the flag inside the EEPROM. The Stylus PHOTO 810/820 takes 80 seconds to complete the initial ink charge sequence and consumes about 1/10 of the brand-new black ink cartridge & about 1/8 of the brand-new color ink cartridge. If the power is turned off during the initial ink charge, the CL1' will be performed at next power on timing.
- Manual Cleaning
The Stylus PHOTO 810/820 provides four types of manual cleaning to clean air bubbles, clogged ink with viscosity or foreign substances.
The following manual CL can be performed by the control panel operation, the printer driver utility and the Adjustment program.
 - CL1
 - Ink absorption
Black Ink: 0.052g, Color Ink: 0.258g
 - Wiping operation
Wipes the nozzle plate by the rubber part on the Cap unit.
 - Flashing operation
Prevents color from mixing, and stabilizes ink surface inside the nozzle.
 - CL1'
 - Ink absorption
Black Ink: 0.27g, Color Ink: 1.33g
 - Wiping operation
Wipes the nozzle plate by the rubber part on the Cap unit.
 - Flashing operation
Prevents color from mixing and stabilizes ink surface inside the nozzle.

- CL1"
 - Ink absorption
Black Ink: 0.52g, Color Ink: 2.58g
 - Wiping operation
Wipes the nozzle plate by the rubber part on the Cap unit.
 - Flashing operation
Prevents color from mixing and stabilizes ink surface inside the nozzle.
- CL2
 - Ink absorption
Black Ink: 0.18g, Color Ink: 0.92g
 - Wiping operation
Wipes the nozzle plate by the rubber part on the Cap unit.
 - Flashing operation
Prevents color from mixing and stabilizes ink surface inside the nozzle.

In case that the manual CL and the nozzle check pattern printing is alternately performed, the CL order is CL1 → CL1' → CL2. (In case that the printer keeps the power off condition more than the specific period, the CL order is CL2 → CL1 → CL1' → CL2 → CL1" → CL2 → CL1 → CL1'.)

Like the previous printers (Stylus COLOR 480/580), CL1 is selected automatically and performed. In case that any printing operation is not performed between each manual CL. Additionally, if the manual CL is performed with over 5 pages printing cycle, CL1 is always selected and performed.

Additionally, if either black or color I/C is ink low or end condition, any manual cleaning is prohibited and it is displayed on the LED indicators.

- Timer Cleaning
Like the previous printers (Stylus COLOR 480/580), this printer does not have Timer IC and Lithium battery which is used for the backup power source for Timer IC. So, this printer manages the printer off period or cleaning cycle by using the following method.
The printer driver sends the timer command to the printer before printing. The timer command is generated based on the PC's timer and it consists of year, month, date, hour, minute and second. As soon as the printer receives the timer command from the printer driver, the printer stores its command in address 04 <H> and 05 <H> in the EEPROM. Then, it is compared with the latest CL time which is stored in address 02 <H> and 03 <H> in the EEPROM. And, in case that the timer

cleaning period is over the specific period, the printer performs the timer cleaning automatically. In this time, the printer stores the timer command in 02 <H>, 03 <H>, 04 <H> and 05 <H> of the EEPROM.

Maximum 0.503 ml of the ink is consumed in the timer cleaning. (0.083ml of black ink and 0.42ml of color ink are consumed.)

- Flashing
This printer performs the following two kinds of the Flashing for the following purpose.
 - Periodical Flashing
This is due to avoid the increment of both ink's viscosity in the printhead nozzle during the continuous printing and the specific small amount of the ink is ejected in the cap based on the periodical flashing timer.
 - Periodical large amount Flashing
This is due to avoid the increment of black ink's viscosity in the printhead nozzle during the continuous printing and large amount of the ink is ejected in the cap based on the periodical large amount flashing timer.

2.2 Electrical Circuit Operating Principles

The electric circuit of the Stylus C60 consists of the following boards.

- Main board: C418 Main/Main-B Board *1
- Power supply board: C417 PSB/PSE Board
(Common board between both printers)

*1 : C418 Main/Main-B board is used for both the Stylus C60 and the Stylus Photo 810/820. Followings show you the specification of the C418 Main/Main-B board.

- For the Stylus C60

- 1) C418 Main : 2 in 1 ASIC + Soldering SOJ ROM (from the first mass production)
- 2) C418 Main/Main-B : 3 in 1 ASIC + Soldering SOJ ROM (Running change)

- For the Stylus Photo 810/820

- 1) C418 Main/Main-B : 3 in 1 ASIC + Soldering SOJ ROM
(from the first mass production)

Note: CPU, ASIC and PROM is integrated as one chip (IC1) on the Main board. This section provides operating principles of C418 Main board and C417 PSB/PSE board. refer to Figure 2-15 for the major connection of the each boards and their roles.

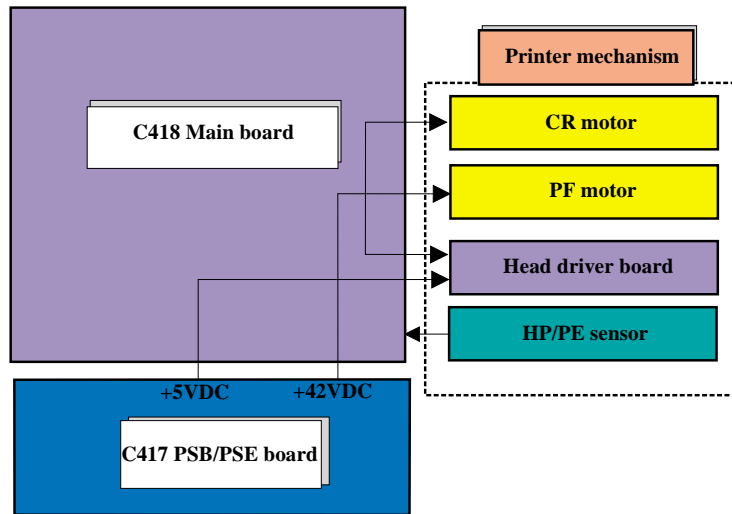

Figure 2-15. Electric circuit

2.2.1 C417 PSB/PSE board

The power supply boards of the Stylus PHOTO 810/820 uses a RCC (Ringing Chalk Converter) circuit, which generates +42VDC for drive line and +5VDC for logic line to drive the printer. The application of the output voltage is described below.

Table 2-6. Application of the DC voltages

Voltage	Application
+42VDC	<ul style="list-style-type: none"> • Motors (CR Motor, PF Motor) • Printhead common voltage • Printhead nozzle selector 42V drive voltage
+5VDC	<ul style="list-style-type: none"> • C418 Main control circuit logic • Sensor

AC voltage input from AC inlet first goes through filter circuit that removes high frequency components and is then converted to DC voltage via the rectifier circuit and the smoothing circuit. DC voltage is then lead to the switching circuit and FET Q1 preforms the switching operation. By the switching operation of the primary circuit, +42VDC is generated and stabilized at the secondary circuit. This +42VDC generated by the secondary circuit is converted to +5VDC by the chopping regulator IC of the secondary circuit.

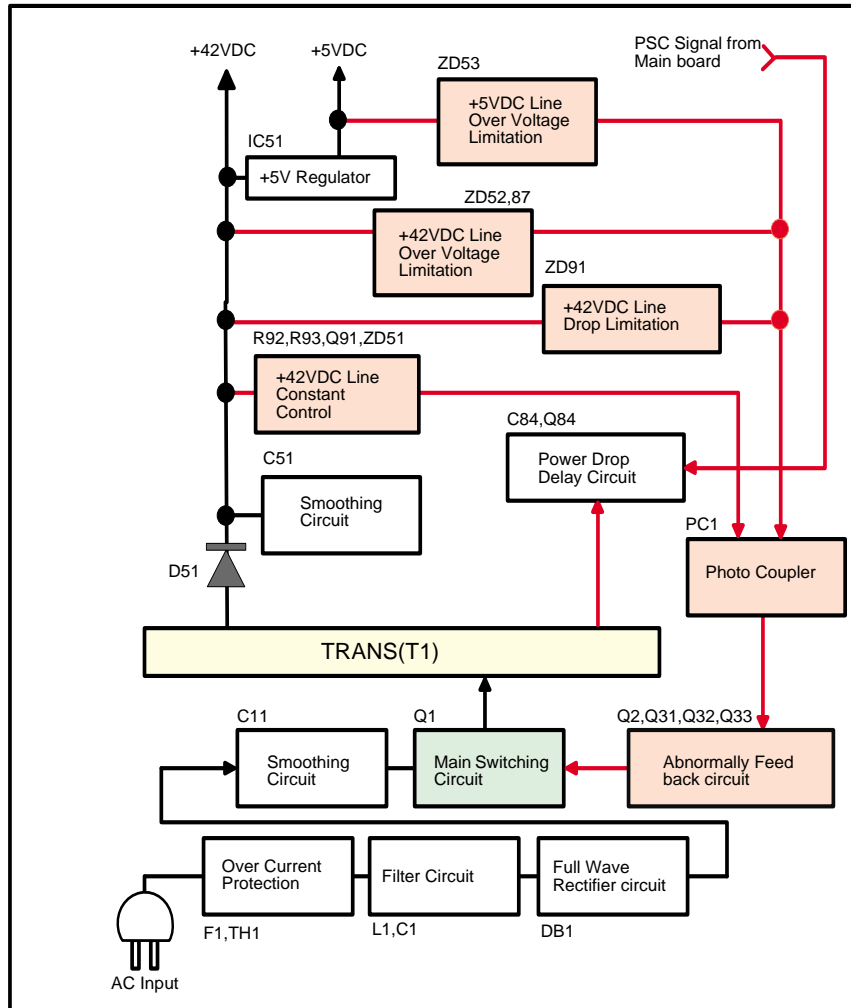

Figure 2-16. C417 PSB/PSE board block diagram

The C417 PSB/PSE board has the various control circuits to stop voltage output if a malfunction occurs on the power supply board or the main board while the printer mechanism is on duty. Following explains each control and protection circuit.

1. Regardless of the state of the power switch (On or OFF), the voltage is always applied to the primary side of the power supply board from the moment or at the state that AC-plug is plugged in. At this time, F1 plays a role of preventing AC100V from coming into the F1. L1 also prevents high harmonic wave noise generated in the RC circuit filter which consists of C1 from going out, and eliminates the noise from outside here.
2. The AC is full-wave rectified by the diode bridge DB1, and converted to $\sqrt{2} \times$ AC in voltage by the smoothing electrolytic capacitor C11.
3. The pressured up direct current turns Q1 on through the starting resistor R31 and starts the primary side of the circuit.
4. When the primary side is On, the energy (current) led by the electromagnetic induction through the trans (T1) does not flow to the secondary side since the diode (D51) on the secondary side is installed in the opposite direction.
5. When the energy which is charged in the trans is reaching the saturated state, the voltage which makes Q1 on becomes weak gradually. At the point that this voltage drops at the certain voltage, C13 absorbs the current in the opposite direction and Q1 is quickly shut off by the resulting sharp drop.
6. When the primary side is turned off, the energy charged in the T1 is opened according to the diode (D51) direction which is installed on the secondary side. Basically, 42 V DC is output by these circuit operations and the number of T1 spiral coil.
7. +5VDC is generated by pressured down this +42VDC as power supply. IC51 pressures down the +42VDC and generates precise +5VDC by chopping off the output, forming the standard sawtooth wave form by the outer RC integration circuit.

The C417 PSB/PSE board has the various control circuits to stop voltage output if a malfunction occurs on the power supply board or the main board or while the printer mechanism is on duty. Following explains each control and protection circuit.

- +42V line constant voltage control circuit :
The output voltage level of the +42V line is monitored by R92, R93, Q91 and ZD51. When +42V line reaches about +42.8V, PC1 starts the operation via Q91. Consequently, FET Q1 switching operation is controlled by this circuit to stabilize the +42V line.

- +42Vline over voltage protection circuit :
The output voltage line is monitored by ZD52 and ZD87. If the output voltage level of +42VDC line exceeds +48V, this circuit stops the operation of the switching FET Q1 via PC1,Q82 and Q83, and prevents high voltage from being applied to the secondary side.
- +42VDC line drop limitation circuit :
PC1 drives with +36V and ZD90 is monitoring the voltage supplied to PC1. If the supplied voltage level exceeds 37V, this circuit shuts down the +42V line temporarily and prevents the over voltage from being applied to the PC1.
- +42Vline over current protection circuit :
The output current level is monitored by the F51. When the abnormal current is detected by F51, F51 blows and cuts off the +42V line output to the Main board.
- +5V line constant voltage control circuit/+5V line over current protection circuit :
The output voltage level of the +5VDC line is monitored by the regulator IC51. If abnormal voltage is detected, the information is fed back to the internal comparator.
- +5V line over voltage protection circuit :
The output voltage level of the +5VDC line is monitored by ZD53.
If the output voltage level of +5VDC line exceeds +7V, this circuit stops the operation of the switching FET Q1 via PC1,Q82 and Q83, and prevents high voltage from being applied to the secondary side.

2.2.2 C418 MAIN/MAIN-B Board

The logic circuit of the C418 Main/Main-B board is composed of the follows;

- Logic line (ASIC, DRAM, P-ROM, EEPROM and so no)
- Motor control/drive circuit (CR motor/PF motor)
- Head control/drive circuit
- Interface control circuit (Parallel I/F, USB I/F)
- Sensor circuit
- Reset circuit
- EEPROM circuit
- Switch circuit
- LED circuit

The printer mechanism is controlled by the above circuits. Following explains the major characteristics of this Main board.

- Timer IC & Lithium battery are not mounted
 Unlike the previous printer (Stylus COLOR 680), the Timer IC and the Lithium battery are not mounted on the Main board. So, this printer performs the Power-on cleaning or Timer cleaning based on the time command which is sent from the PC through the printer driver. As for the details, refer to 2.1.6
- Use of the 3.3V chips in the logic circuit
 The 3.3V regulator (IC8) on the C418 Main/Main-B board generates 3.3VDC by pressuring down the 5VDC to drive several chips for the logic circuit.

Table 2-7. 3.3VDC drive chips & 5VDC drive chips

5VDC	3.3VDC
Motor driver (IC10/11)	ASIC (IC1)
Reset IC (IC2)	D-RAM (IC4)
EEPROM (IC3)	P-ROM (IC5)
Parallel controller (IC7)	Parallel controller (IC7)
	Common driver (IC19)

- Unlike the previous printer (Stylus COLOR 680), the panel board is eliminated and the switches/LED lights are mounted on the Main board.
- The transceiver with USB I/F is built in the CPU.
- D-RAM
 4Mbit D-RAM is mounted on the Main board.
- One ASIC controls the all functions on the Main board.
 refer to Figure 2-17 for the 418 Main board block diagram.

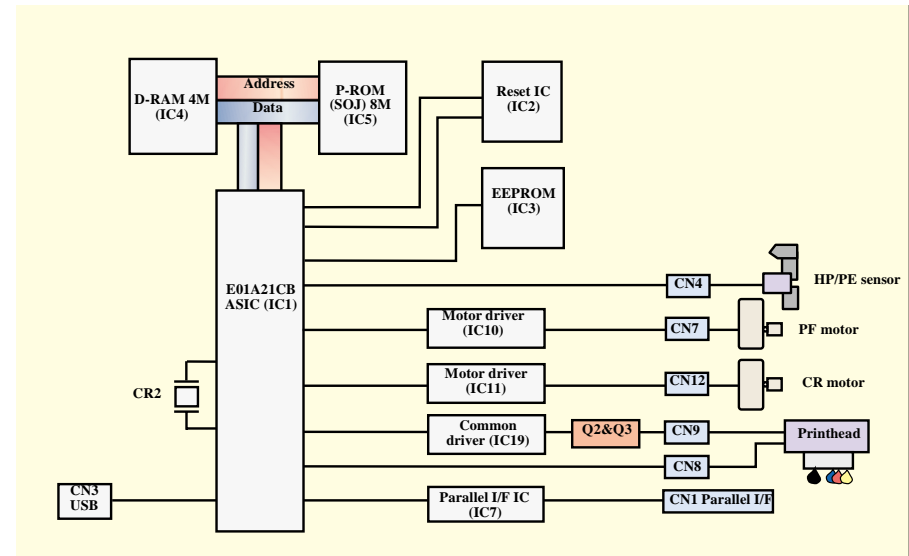

Figure 2-17. Block diagram for the C418 Main/Main-B board

2.2.2.1 Main Elements

Table 2-8 shows the function of the each main elements on C418 Main/Maia-B board.

Table 2-8. Main elements

IC	Location	Function
CPU E01A21CB (E01A21CA)	IC1	CPU mounted on the MAIN board is driven by clock frequency 48 MHz, 24MHz and controls the printer.
DRAM	IC4	Bus= 16 bit, 4Mbit DRAM
EEPROM	IC3	1kbit EEPROM <ul style="list-style-type: none"> • Default value setting • Parameter backup
Reset IC BN6150F-E2	IC2	Reset IC <ul style="list-style-type: none"> • For +5V; reset when +4.2V is detected • For +42V, reset when +36.3 V is detected
Common Driver E09A29LA	IC19	Head drive control HIC <ul style="list-style-type: none"> • Generates head common voltage.
Motor Driver (LB1946-K)	IC10/IC11	PF/CR motor drive IC
Parallel I/F IC 74LVX1612B4	IC7	IEEE1284 parallel I/F transceiver IC.

2.2.2.2 Printhead Driver Circuit

The printhead driver circuit consists of the following two components:

- Head common driver circuit (Common driver IC19 & Wave amplifier transistor Q2, Q3)
- Nozzle selector IC on the printhead driver

The common driver (IC19) generates a basic drive waveform according to the output signals from CPU (IC1). The basic drive waveform is amplified by the transistors Q2 and Q3 (the amplified one is called drive waveform.) and then transferred to the nozzle selector IC on the printhead driver board. Print data is converted to serial data by the CPU and then sent to the nozzle selector IC on the printhead driver board. Based on the serial data, the nozzle selector IC determines the nozzles to be actuated. The selected nozzles are driven by the drive waveforms amplified by the transistor Q2 and Q3. See refer to Figure 2-18 for the printhead driver circuit block diagram.

□ Head common driver circuit

The basic drive waveform is generated in the common driver (IC19) based on the following 12 signal lines output from the CPU (IC1); A0-A4, CLK1, CLK2, FLOOR, RST, DATA, DCLK, and E.

By the DATA signal output from the CPU, the original data for the basic drive waveform is written in the memory in the common driver (IC19). The addresses for the written data are determined by A0-A4 signals. Then, the necessary data is selected from the address and appropriate basic drive waveform is generated. Generated basic drive waveform is transferred to nozzle selector IC on the printhead driver board through the transistor Q2 and Q3 and applied to the nozzle PZT specified by nozzle selector IC.

□ Nozzle selector circuit

Printing data is allocated to the six rows (the number of the head nozzle rows) and converted into serial data by the CPU (IC1). Then the converted data is transferred to the nozzle selector IC through the six signals lines (HSO1 to HS06). Data transmission from the CPU to the nozzle selector synchronizes with the LAT signal and SCK clock signal. Based on the transmitted data, appropriate nozzle is selected and the PZTs of the selected nozzle are driven by the drive waveform output from the head common driver.

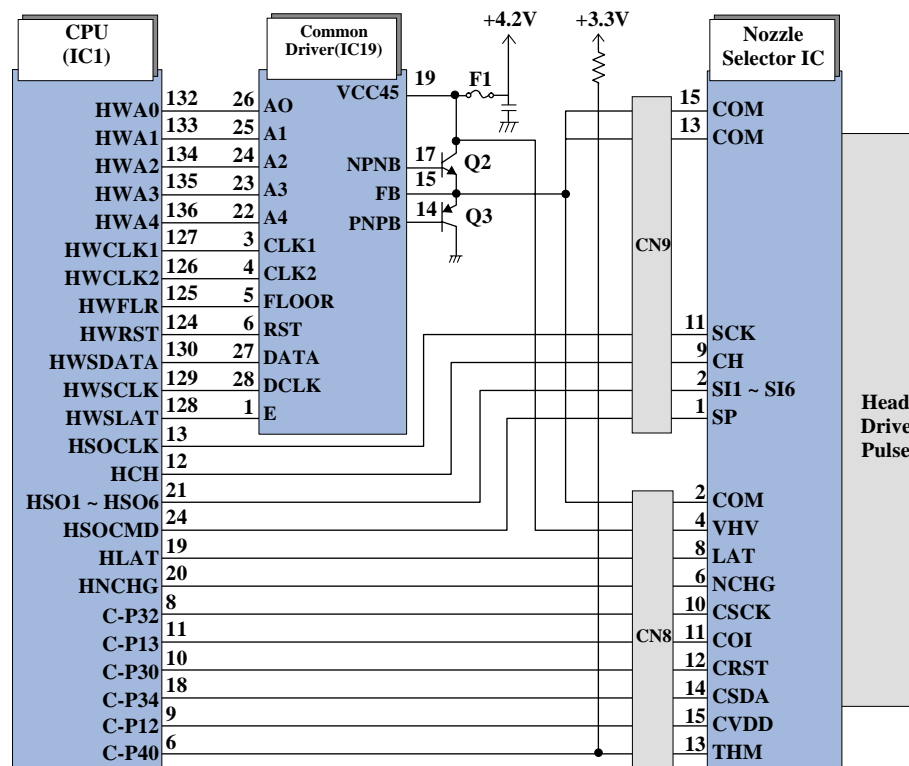

Figure 2-18. Printhead driver circuit

2.2.2.3 PF Motor (PF/ PUMP/ ASF Motor) Driver Circuit

The motor driver IC (IC10) on the Main board drives PF motor. This product uses 4-phase 96-poles hybrid type stepping motor and performs constant current bi-polar drive.

CPU (IC1) transmits LB1946 micro step drive form and the current value data on each phase to motor driver IC (IC10) from port 139. Based on this signal, motor driver IC determines the phase mode.

Motor driver IC generates motor driver waveform based on these input signals and controls the motor. And also, motor driver IC monitors to prevent the fluctuations in the actual current value to motor driver IC. If motor driver IC detects the fluctuations in the actual current value, it amends the current value internally.

In case that the printer dose not receive any data for 5 minutes, CPU set the motor drive current to 0 [A] and the motor drive is turned off to save the power consumption.

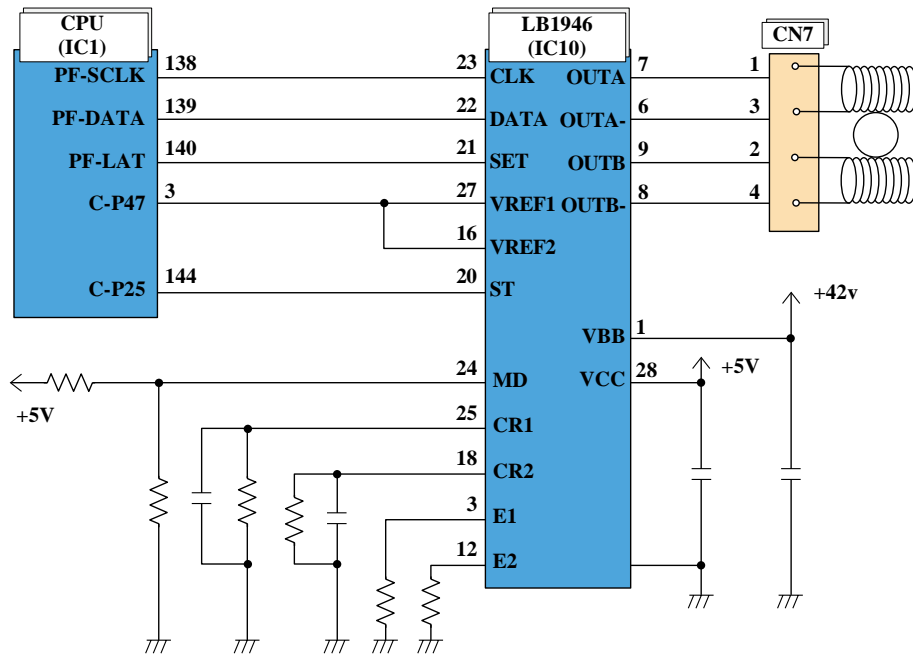

Figure 2-19. PF motor driver circuit block diagram

2.2.2.4 CR Motor Driver Circuit

The motor driver IC (IC11) on the Main board drives CR motor. This product uses 4-phase 200-poles hybrid type stepping motor and performs constant current bi-polar drive.

CPU (IC1) transmits LB1946 micro step drive form and the current value data on each phase to motor driver IC (IC11) from port 142. Based on this signal, motor driver IC determines the phase mode.

Motor driver IC generates motor driver waveform based on these input signals and controls the motor. And also, motor driver IC monitors to prevent the fluctuations in the actual current value to motor driver IC. If motor driver IC detects the fluctuations in the actual current value, it amends the current value internally.

In case that the printer dose not receive any data for 5 minutes, CPU set the motor drive current to 0 [A] and the motor drive is turned off to save the power consumption.

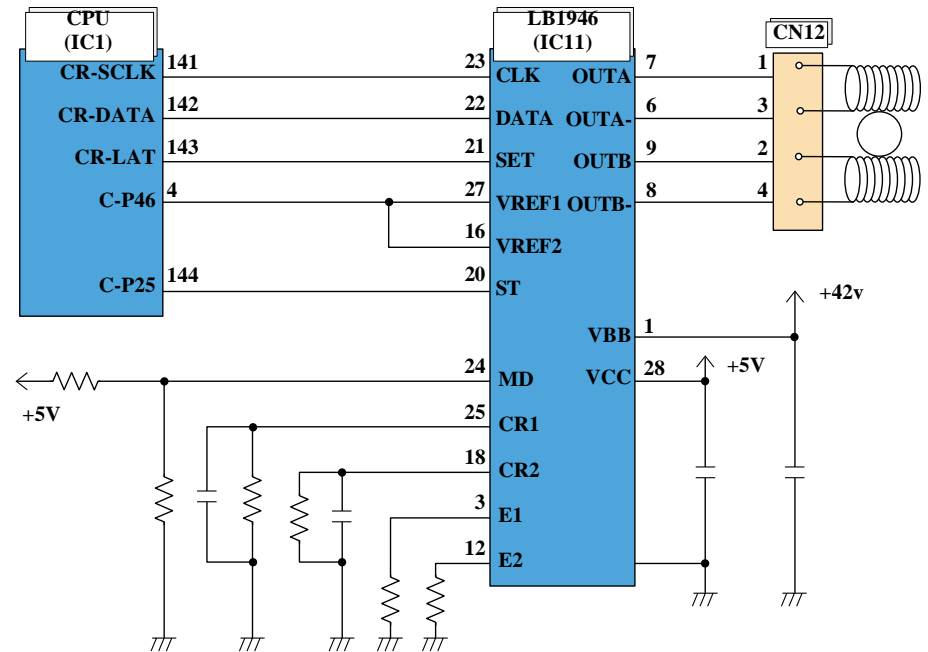

Figure 2-20. CR motor driver circuit block diagram

2.2.2.5 Reset Circuit

Reset IC (IC2) on the MAIN board monitors the two voltage: +5V for the logic line and +42V for the drive line. Reset IC outputs the reset signal to CPU (IC1) in the following case.

1. When the printer power is turned on and reset IC detects 4.2V on +5V line/36.3V on +42V line, reset signal is output to perform the initialize operation correctly.
2. When the printer power is turned off and reset IC detects 4.2V on +5V line/36.3V on +42V line, reset signal is output to stop the printer operation safely.
3. When reset IC detects 4.2V on +5V line/36.3V on +42V line with fail during the printer operation, reset signal is output to stop the printer operation safely.

Unlike the previous products, the timer IC is not built in the reset IC and the Lithium battery is not mounted on this Main board either.

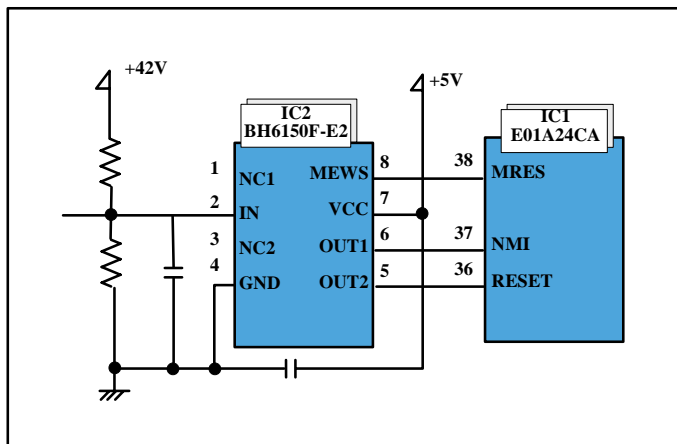

Figure 2-21. Reset circuit block diagram

Main line for reset IC has the following function.

- OUT1: Interrupt signal
- OUT2: Reset line
- IN: +42V line monitoring line
- VCC: +5V line monitoring line

2.2.2.6 EEPROM Control Circuit

When the printer power is turned off, the following information is stored in EEPROM (IC3) which is nonvolatile memory. And, when the printer power is on, CPU (IC1) reads the information from EEPROM.

Information stored in EEPROM is listed below.

- Various ink counter (I/C consumption counter, waste pad counter, etc.)
- Mechanical setting value (Head ID, Bi-D adjustment, USB ID, etc.)

Refer to 7.1.2 that provides the detailed information stored in EEPROM.

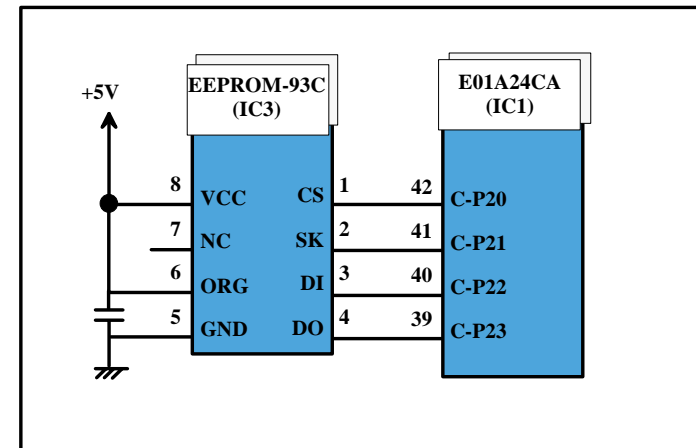

Figure 2-22. EEPROM circuit diagram

EEPROM is connected to CPU with 4 lines and each line has the following function.

- CS: Chip selection signal
- CK: Data synchronism clock pulse
- DI: Data writing line (serial data) at power off.
- DO: Data reading line (serial data) at power on.

2.2.2.7 Sensor Circuit

CPU (IC1) on the Main board monitors the status of the printer by several sensors. However, unlike the previous product, ASF unit on this printer does not have ASF sensor. Instead of ASF sensor, Change lever and the Clutch mechanism is used to detect ASF home position. (As for the ASF home position detection, refer to 2.1.4.)

□ HP/PE sensor

HP/PE sensor uses photo interrupter method and always monitors the two status during the printer is in the power on status.

The photo interrupter component and two detection levers consists of this sensor.

■ CR home position

The CR home position is detected on the right edge of the CR shaft with the HP/PE sensor during the variety sequence. In case that the CR home position is detected, this sensor outputs HIGH signal to the CPU (IC1).

If CR home position is not detected in the detection position correctly, this sensor outputs LOW signal to CPU and the printer indicates the error (As for the error indication, refer to 1.4.3.)

■ Paper top & end position

When the Paper is in the paper path during the paper loading/feeding sequence, HP/PE sensor outputs the HIGH signal.

When the Paper is not in the paper path, this sensor outputs the LOW signal and the printer indicates the error (As for the error indication, refer to 1.4.3.)

□ Thermistor (THM)

The thermistor is directly mounted on the printhead driver board. It monitors the temperature around the printhead and determines the proper head drive voltage to uniform the weight of the ink fired from printhead. This information is fed back to the CPU analog port. When the temperature rises, the head drive circuit lowers the drive voltage: When the temperature lowers, the head drive circuit rises the drive voltage.

The block diagram for the sensor circuit is shown below.

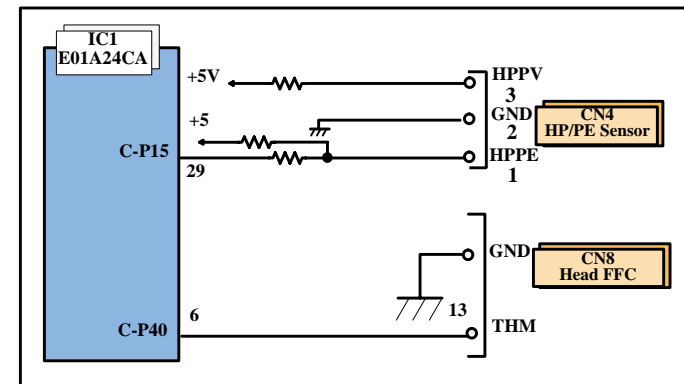

Figure 2-23. Sensor circuit diagram

CHAPTER

3

TROUBLESHOOTING

3.1 Overview

This chapter describes how to identify troubles in two levels: unit level repair and component level repair. Refer to the flowchart in this chapter to identify the defective unit and perform component level repair if necessary. This chapter also explains motor coil resistance, sensor specification and error indication.

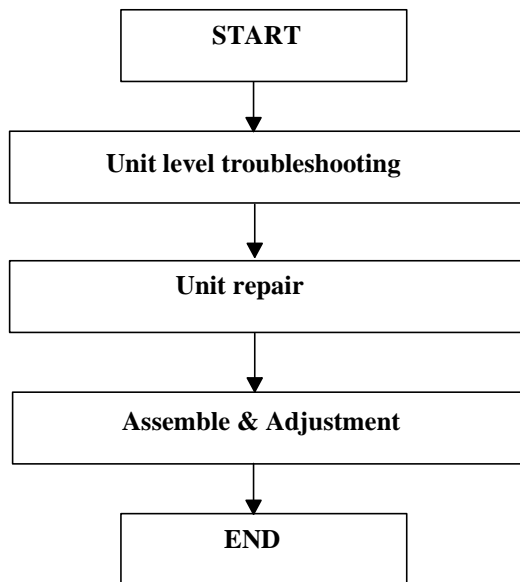

Figure 3-1. Troubleshooting flowchart

Table 3-1. Motor, coil resistance

Motor	Location	Check point	Resistance
CR motor	CN12	Pin 1 and 3 Pin 2 and 4	7.8 Ohms ± 10% (at 25 °C/ phase)
PF motor	CN7	Pin 1 and 3 Pin 2 and 4	6.0 Ohms ± 10% (at 25 °C/ phase)

Table 3-2. Sensor check point

Sensor name	Check point	Signal level	Switch mode
HP/PE Sensor	CN4/Pin 1 and 2	Less than 0.7V	Off <ul style="list-style-type: none"> • Out of CR home position • No paper
		More than 2.4V	On <ul style="list-style-type: none"> • Within CR home position • Detect the paper
Thermistor (THM)	TH1 (on the Head driver board)	Analog signal	10 K (at 25 °C)

3.2 Troubleshooting with LED Error Indications and Status Monitor 3 Message

This section describes the LED indication, the STM3 message and the error detection condition when the printer detects an error condition in each sequence/operation (such as the power on sequence, the paper loading/feeding sequence, the ink absorption sequence,

Table 3-3. Error indication and status monitor 3

Printer status	Indicators		Status monitor 3 message	Condition for error detection
	Power	Error		
Fatal error	Off	On		<p>This error is detected when ;</p> <ol style="list-style-type: none"> 1) the CR unit cannot move correctly by the external force in each sequence/operation 2) the PF motor cannot rotate correctly while the PF motor operates.
Maintenance request	Alt Blink	Alt Blink		<p>This error is detected when the protection counter A stored into EEPROM reaches the limit (32915 points).</p>

Table 3-3. Error indication and status monitor 3

Printer status	Indicators		Status monitor 3 message	Condition for error detection
	Power	Error		
Paper jam error	On	On		<p>This error is detected when ;</p> <ol style="list-style-type: none"> 1) the end of a paper is not correctly detected with the HP/PE sensor in the paper feeding sequence. 2) the HP/PE sensor cannot detect that the CR unit moves outside the home position in the CR home position detection sequence.
Paper out error	On	On		<p>This error is detected when the top of a paper is not detected with the HP/PE sensor in the paper loading sequence.</p>

Table 3-3. Error indication and status monitor 3

Printer status	Indicators		Status monitor 3 message	Condition for error detection
	Power	Error		
No ink cartridge (Black and Color)	On	On	 <p>The screenshot shows a dialog box titled 'EPSON Status Monitor 3 : EPSON Stylus Photo 810 Series'. The main message is 'Black and color ink cartridges not correctly installed'. Below this, it lists 'Black: T026' and 'Color: T027' and states 'The genuine EPSON ink cartridges listed above are recommended for replacement. Click the How to button for ink cartridge installation'. There are 'How to...' and 'OK' buttons. At the bottom, there are 'Ink Levels' for 'Black Ink T026' and 'Color Ink T027' with 'Information' and 'Technical Support' buttons.</p>	<p>This error is detected when ;</p> <ol style="list-style-type: none"> 1) the ink cartridge is not installed to the CR unit. 2) the ink cartridge is defective.
Ink end error	On-> Blink	<p>[Bk I/C] On -> Blink</p> <p>[Col I/C] On -> Blink2</p>	 <p>The screenshot shows a dialog box titled 'EPSON Status Monitor 3 : EPSON Stylus Photo 810 Series'. The main message is 'Black and color inks out'. Below this, it lists 'Black: T026' and 'Color: T027' and states 'The genuine EPSON ink cartridges listed above are recommended. Click the How to button for ink cartridge replacement instructions.' There are 'How to...' and 'OK' buttons. At the bottom, there are 'Ink Levels' for 'Black Ink T026' and 'Color Ink T027' with 'Information' and 'Technical Support' buttons. Red 'X' marks are placed over the ink level indicators.</p>	<p>This error is detected when ;</p> <ol style="list-style-type: none"> 1) the ink consumption amount reaches 100% 2) the ink cartridge is defective. <p>[Note] The slight amount of the ink is remaining in the I/C even if the ink end error is detected. This is to prevent the Printhead nozzle from the printing operation without firing the ink.</p>

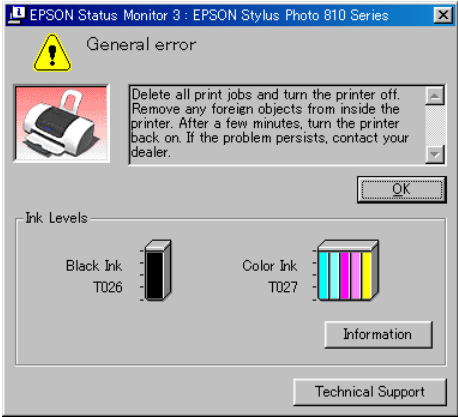
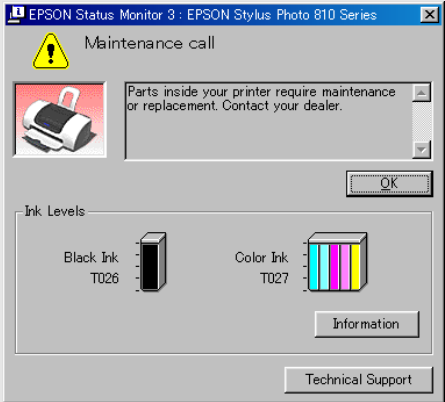
" A -> B " : A is a indicator condition when the CR unit is in the home position.

B is a indicator condition in the ink replacement sequence.

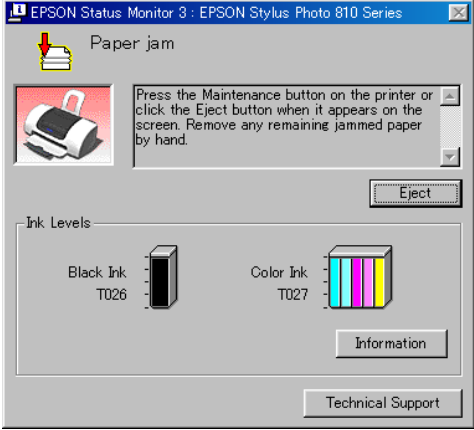
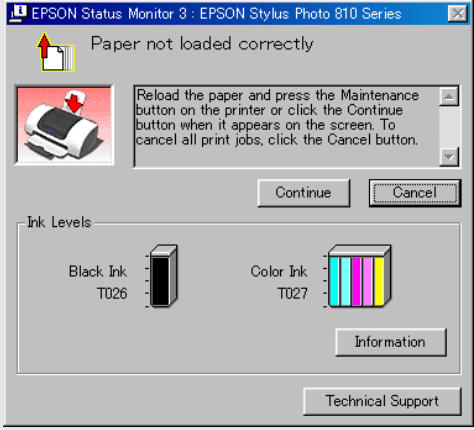
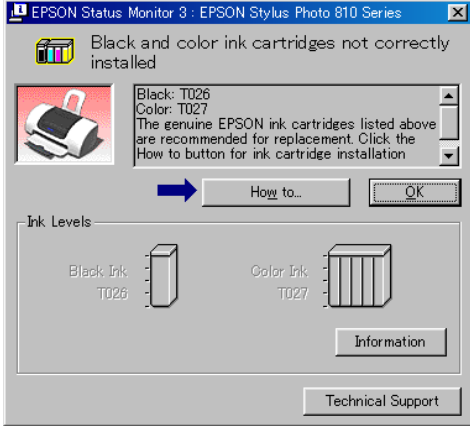
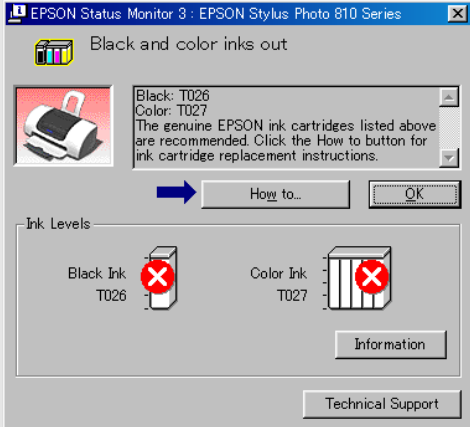
Blink : On 0.5sec + Off 0.5sec

Blink2 : On 0.2sec + Off 0.2sec + On 0.2sec + Off 0.4sec

Table 3-3. Error indication and status monitor 3

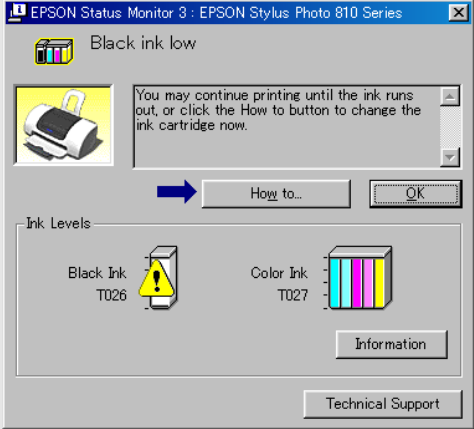
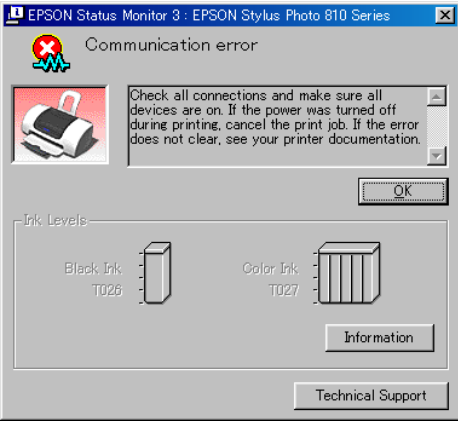
Printer status	Indicators		Status monitor 3 message	Condition for error detection
	Power	Error		
Ink low condition	On-> Blink	[Bk I/C] Blink -> Blink [Col I/C] Blink -> Blink2	 <p>Note : Even if this error is indicated on the STM3, you can continue the printing until I/C becomes ink end condition. However, the head cleaning operation cannot be done so that the remaining ink is low condition.</p>	<p>This error is detected when the ink consumption amount reaches about 90%.</p> <p>[Note] When the ink low condition is detected, Error reset LED is blinking. The printer continue to keep this LED status even if brand new ink cartridge is installed at the I/C replacement position. Then, when the CR unit returns to the home position, this LED status is reset (LED is off).</p>
Communication error	Off	Off		<p>This error is detected when the printer cannot communicate with the PC correctly.</p>

" A -> B " : A is a indicator condition when the CR unit is in the home position.

B is a indicator condition in the ink replacement sequence.

Blink : On 0.5sec + Off 0.5sec

Blink2 : On 0.2sec + Off 0.2sec + On 0.2sec + Off 0.4sec

Table 3-3. Error indication and status monitor 3

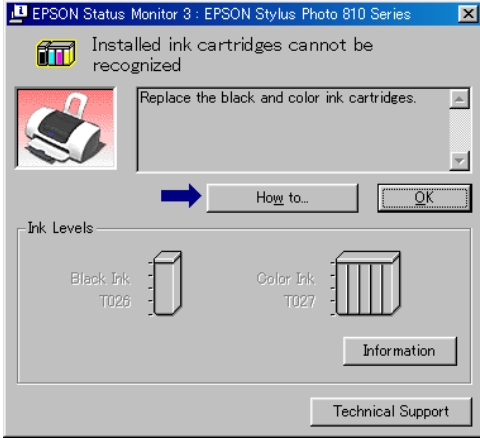
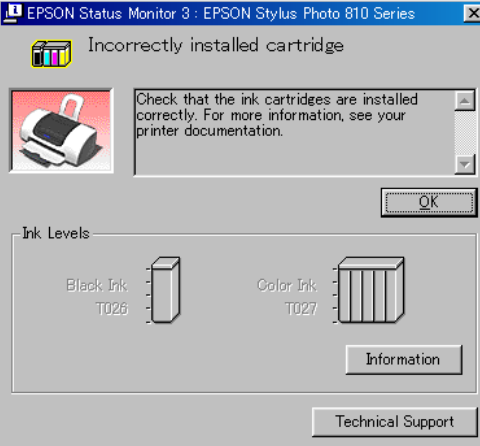
Printer status	Indicators		Status monitor 3 message	Condition for error detection
	Power	Error		
Error before the ink replacement CL	On	On		This error is detected when the 2nd or more ink cartridge for the ink replacement CL is defective.
Error before the initial ink charge	On	On		This error is detected when the 1st ink cartridge for the initial ink charge is defective.

3.3 Unit Level Troubleshooting

You can identify the troubles by using the checklist in this section after confirming the LED indication on the printer. If you connect the printer to your PC and see an error message on the STM3, you can short the total repair time. And, when you find out the defective parts, replace them by referring the Chapter 4 “Disassembling”. Following tables describe the error condition (LED and STM3), possible cause and check point.

The following is the example of how to use the table.

When the CR unit is out of the home position at the power on timing, the fatal error may be caused by the failure of the CR motor. Moreover, there are 3 possible causes on the CR motor failure.

[Note]

When the individual part of the Paper eject roller, PF motor and the Ink system unit is defective, replace the Printer mechanism to new one basically.

However, if the individual part is replaced to new one in the urgent case, disassembly/reassemble it carefully by referring to Chapter 4.

Table 3-4. Fatale error condition and possible cause

Error condition	LED indication STM3 message	Occurrence timing	CR position at the power on timing	Defective unit/part name	Possible cause	Check table
Fatal error	Power : Off Error : On General error	Power on	Outside HP	CR motor	The CR motor connector cable comes off.	Refer to Table 3-5
					The CR motor is defective.	
					The CR motor connector cable is damaged.	
				Holder shaft unit	The Paper return plate disturbs the rotation of the LD roller.	
				PF motor	The PF motor connector cable comes off.	
					The PF motor is defective.	
			The PF motor connector cable is damaged.			
			Paper guide upper/left	The Paper guide upper/left comes off completely.		
		Pump unit	The Compression spring 1.764 comes off.			
		Anywhere	Main board	The Main board is defective.		
			Main frame	The Main frame is deformed.		
Operation	-		Front frame	The Front frame is bent up.		
	-	Main frame	The Main frame is deformed.			

Table 3-5. Check point for the fatal error according to each phenomenon



Occurrence timing CR position	Detailed phenomenon	Defective unit/part name	Check point	Remedy
Power on Outside HP	When turning on the power, the CR motor does not operate at all.	CR motor	1. Check if the CR motor connector cable is connected to CN12 on the Main board. 2. Check if the coil resistance of the CR motor is about 7.8 ohm by using the tester. Refer to Table 3-1. 3. Check if the CR motor connector cable is damaged.	1. Connect the CR motor connector cable to CN12 on the Main board. 2. Replace the CR motor with new one. 3. Replace the CR motor with new one.
	When turning on the power, the CR unit collides to the Change lever located to the front side of the printer.	Holder shaft unit	1. Check if the Paper return plate disturbs the rotation of the LD roller. 	1. Reassemble the ASF unit to the printer.
		PF motor	1. Check if the PF motor connector cable is connected to CN7 on the Main board. 2. Check if the coil resistance of the PF motor is about 6.0 ohm by using the tester. Refer to Table 3-1. 3. Check if the PF motor connector cable is damaged.	1. Connect the PF motor connector cable to CN7 on the Main board. 2. Replace the Printer mechanism with new one. 3. Replace the Printer mechanism with new one.
		Pump unit	1. Check if the Compression spring 1.764 comes off in the Change lever. 	1. Replace the Printer mechanism with new one.
	When turning on the power, the CR unit collides to the Paper guide upper located on the Lower housing.	Paper guide upper/left	1. Check if the Paper guide upper/left comes off from the Main frame. 	1. Reassemble the Paper guide upper/left to the Main frame.

Table 3-5. Check point for the fatal error according to each phenomenon

Occurrence timing CR position	Detailed phenomenon	Defective unit/part name	Check point	Remedy
Power on Anywhere	When turning on the power, the CR unit collides to the right side of the Main frame.	Main frame	1. Check if the CR home position is correctly detected with the HP/PE sensor.	1. Replace the Printer mechanism with new one. * If the problem is not solved, replace the Main board with new one.
Operation -	The CR unit climbs over the Slider lock lever set to the wiping position and the CR unit collides to its lever.	Main frame	1. Check if the Slider lock lever is correctly released by the CR movement.	1. Replace the Printer mechanism with new one.
		Front frame	1. Check if the Slider lock lever is correctly released by the CR movement.	1. Replace the Front frame with new one.

Table 3-6. Paper jam error condition and possible cause

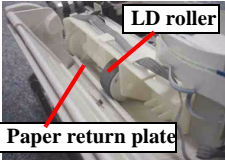
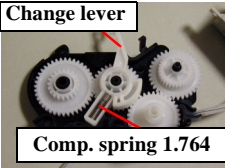
Error condition	LED indication STM3 message	Occurrence timing	CR position at the power on timing	Unit/Part name	Possible cause	Check table	
Paper jam error	Power : On Error : On Paper jam	Power on	Inside HP	CR motor	The CR motor connector cable comes off.	Refer to Table 3-7	
					The CR motor is defective.		
					The CR motor connector cable is damaged.		
				Holder shaft unit	The Paper return plate disturbs the rotation of the LD roller.		
				PF motor	The PF motor connector cable comes off.		
					The PF motor is defective.		
			The PF motor connector cable is damaged.				
			Pump unit	The Compression spring 1.764 comes off.			
			Anywhere	ASF unit	The Compression spring 29.1 comes off.		
					LD roller unit		The Torsion spring 0.22 for PE sensor lever comes off.
							The Torsion spring 0.22 for HP sensor lever comes off.
							The HP/PE sensor is defective.
The HP/PE sensor cable comes off.							
The HP/PE sensor cable is damaged.							
The HP/PE sensor cable is not placed correctly.							

Table 3-6. Paper jam error condition and possible cause

Error condition	LED indication STM3 message	Occurrence timing	CR position at the power on timing	Unit/Part name	Possible cause	Check table
Paper jam error	Power : On Error : On Paper jam	Operation	Outside HP	Holder shaft unit	The Torsion spring 0.22 for HP sensor lever comes off.	Refer to Table 3-7
					The HP/PE sensor cable is not placed correctly.	
			-	ASF unit	The Compression spring 29.1 comes off.	
				Front frame	The Star wheel comes off.	
					The Front frame is bent down.	
					The Front frame is not assembled correctly.	
				Holder shaft unit	The Torsion spring 0.22 for PE sensor lever comes off.	
				Lower housing	The porous pad for the “no margin” printing comes off.	
				Paper eject roller unit	The Paper eject roller shaft comes off. *	
The Spur gear 60 comes off.						
Paper guide upper/left	The Paper guide upper/left comes off completely.					

Table 3-7. Check point for the paper jam error according to each phenomenon

Occurrence timing CR position	Detailed phenomenon	Defective unit/part name	Check point	Remedy
Power on Inside HP	When turning on the power, the CR unit does not operate at all.	CR motor	<ol style="list-style-type: none"> 1. Check if the CR motor connector cable is connected to CN12 on the Main board. 2. Check if the coil resistance of the CR motor is about 7.8 ohm by using the tester. Refer to Table 3-1. 3. Check if the CR motor connector cable is damaged. 	<ol style="list-style-type: none"> 1. Connect the CR motor connector cable to CN12 on the Main board. 2. Replace the CR motor with new one. 3. Replace the CR motor with new one.
	When turning on the power, the CR unit collides to the Change lever located to the front side of the printer.	Holder shaft unit	<ol style="list-style-type: none"> 1. Check if the Paper return plate disturbs the rotation of the LD roller. 	<ol style="list-style-type: none"> 1. Reassemble the ASF unit to the printer.

Table 3-7. Check point for the paper jam error according to each phenomenon

Occurrence timing CR position	Detailed phenomenon	Defective unit/part name	Check point	Remedy
Power on Inside HP	When turning on the power, the CR unit collides to the Change lever located to the front side of the printer.	PF motor	1. Check if the PF motor connector cable is connected to CN7 on the Main board. 2. Check if the coil resistance of the PF motor is about 6.0 ohm by using the tester. Refer to Table 3-1. 3. Check if the PF motor connector cable is damaged.	1. Connect the PF motor connector cable to CN7 on the Main board. 2. Replace the Printer mechanism with new one. 3. Replace the Printer mechanism with new one.
	When turning on the power, the CR unit collides to the Change lever located to the front side of the printer.	Pump unit	1. Check if the Compression spring 1.764 comes off in the Change lever. 	1. Replace the Printer mechanism with new one.
Power on Anywhere	When turning on the power, the paper feeding sequence is performed without loading a paper in the paper loading sequence.	ASF unit	1. Check if the Paper return plate operates correctly in the paper loading sequence.	1. Reassemble the Tension spring 29.1 between the ASF frame and the Paper return plate. 
		Holder shaft unit	1. Check if the Torsion spring 0.22 comes off on the both HP sensor lever and PE sensor lever.  2. The HP/PE sensor is defective. 3. Check if the HP/PE sensor cable comes off. 4. Check if the HP/PE sensor cable is damaged. 5. Check if the HP/PE sensor cable is correctly placed on the LD shaft holder.	1. Set the Torsion spring 0.22 to the suitable position of the both levers. 2. Replace the Holder shaft unit with new one. 3. Replace the Holder shaft unit with new one. 4. Replace the Holder shaft unit with new one. 5. Replace the Holder shaft unit with new one.

Table 3-7. Check point for the paper jam error according to each phenomenon

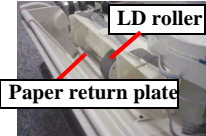

Occurrence timing CR position	Detailed phenomenon	Defective unit/part name	Check point	Remedy
Operation Outside HP	When turning on the power, the CR unit move to the home position correctly. But, the paper feeding sequence is performed without loading a paper in the paper loading sequence.	Holder shaft unit *	<ol style="list-style-type: none"> 1. Check if the Torsion spring 0.22 for the HP sensor lever comes off. 2. Check if the HP/PE sensor cable is correctly placed on the LD shaft holder. 	<ol style="list-style-type: none"> 1. Set the Torsion spring 0.22 to the suitable position of the HP sensor lever. 2. Place the HP/PE sensor cable correctly.
Operation -	When a top of a paper at the correct timing during the paper loading sequence, the paper is ejected immediately without setting the paper setting position for printing. But, in this time, next paper is loaded to the PE detection lever.	ASF unit	<ol style="list-style-type: none"> 1. Check if the Paper return plate operates correctly in the paper loading sequence. 	<ol style="list-style-type: none"> 1. Reassemble the Tension spring 29.1 between the ASF frame and the Paper return plate. 
	The top of a paper does not go through between the Paper eject roller and the Star wheel.	Front frame **	<ol style="list-style-type: none"> 1. Check if the Star wheel comes off. 2. Check if the Front frame is bent down. 3. Check if the Front frame is correctly assembled. 	<ol style="list-style-type: none"> 1. Reassemble the Star wheel correctly. 2. Replace the Front frame with new one. 3. Reassemble the Front frame correctly.
		Lower housing	<ol style="list-style-type: none"> 1. Check if the porous pad in the Lower housing comes off. 	<ol style="list-style-type: none"> 1. Reassembly the porous pad correctly.
		Paper eject roller unit **	<ol style="list-style-type: none"> 1. Check if the Paper eject roller shaft is correctly assembled. 2. Check if the Spur gear 60 comes off. 	<ol style="list-style-type: none"> 1. Reassemble the Paper eject roller shaft to the Lower housing correctly. 2. Replace the Printer mechanism with new one. <p>* The left figure is the Paper eject roller unit for the Stylus C60. Different from the plastic shaft for the Stylus C60, The one for Stylus Photo 810/820 is metal shaft.</p>
A paper is loaded from the ASF unit, and it is fed correctly. But, the paper feeding sequence is performed without loading a paper from the next paper loading sequence.	Holder shaft unit	<ol style="list-style-type: none"> 1. Check if the Torsion spring 0.22 for the PE sensor lever comes off. 	<ol style="list-style-type: none"> 1. Set the Torsion spring 0.22 for the PE sensor lever to the suitable position. 	

Table 3-7. Check point for the paper jam error according to each phenomenon

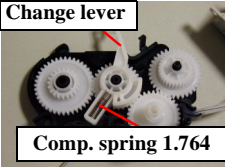
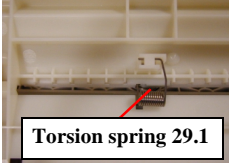
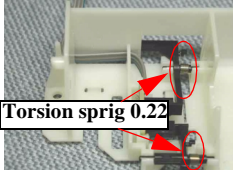
Occurrence timing CR position	Detailed phenomenon	Defective unit/part name	Check point	Remedy
Operation -	The top of a paper is not loaded to the PF roller.	Paper guide upper/left **	1. Check if the Paper guide upper/left is correctly assembled. 	1. Reassemble the Paper guide upper/left to the Main frame correctly.

* The CR unit can move to home position even if the Tension spring 0.22 comes off or the HP/PE sensor is not correctly placed. However, the HP detection lever keeps the high signal condition in the next operation. Therefore, the paper jam error is detected.

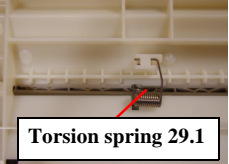
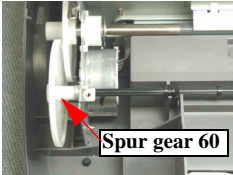
** In case that the paper jam error occurs in each operation, the jammed paper contacts the nozzle surface of the Printhead and the Printhead may be damaged.

Table 3-8. Paper out error condition and possible cause

Error condition	LED indication STM3 message	Occurrence timing	CR position at the power on timing	Unit/Part name	Possible cause	Check table
Paper out error	Power : On Error : On Paper not loaded correctly	Operation	-	ASF unit	The Compression spring 2.50 comes off.	Refer to Table 3-9
					The Tension spring 29.1 comes off.	
				Holder shaft unit	The Tension spring 0.143 comes off.	
					The Dowel in Clutch comes off.	
					The Clutch tooth is damaged.	
					The Clutch is damaged.	
					The friction of the LD roller is lowered.	
				Paper guide upper/left	The Paper return plate disturbs the rotation of the LD roller.	
				PF motor	The Paper guide upper (only HP side) comes off.	
					The PF motor connector cable comes off.	
The PF motor is defective.						
					The PF motor connector cable is damaged.	

Table 3-8. Paper out error condition and possible cause

Error condition	LED indication STM3 message	Occurrence timing	CR position at the power on timing	Unit/Part name	Possible cause	Check table
Paper out error	Power : On Error : On	Operation	-	Pump unit	The Compression spring 1.764 comes off.	Refer to Table 3-9
	Paper not loaded correctly				The tip of the Change lever is damaged.	

Table 3-9. Check point for the paper out error according to each phenomenon

Occurrence timing CR position	Detailed phenomenon	Defective unit/part name	Check point	Remedy
Operation -	The Hopper does not operate during the paper loading sequence although the LD roller rotates to load a paper from ASF unit.	ASF unit	1. Check if the Hopper operates correctly in the paper loading sequence.	1. Reassemble the Compression spring 2.50 between the ASF frame and the Hopper.  Comp. Spring 2.50
	When a top of a paper at the correct timing during the paper loading sequence, the paper is ejected immediately without setting the paper setting position for printing.		1. Check if the Paper return plate operates correctly in the paper loading sequence.	1. Reassemble the Tension spring 29.1 between the ASF frame and the Paper return plate.  Torsion spring 29.1

Table 3-9. Check point for the paper out error according to each phenomenon

Occurrence timing CR position	Detailed phenomenon	Defective unit/part name	Check point	Remedy
Operation -	The LD roller does not attempt to load a paper during the paper loading sequence although the PF motor and the Spur gear 60 rotate. (But, the drive of the PF motor is not transmitted to the LD roller shaft.)	Holder shaft unit	1. Check if the Tension spring 0.143 comes off in the Clutch mechanism. 2. Check if the Clutch comes off from the dowel of the LD roller shaft. 3. Check if the Clutch tooth is damaged. 	1. Reassemble the Torsion spring 0.143 in the Clutch mechanism. 2. Reassemble the round portion of the Clutch on the dowel of the LD roller shaft. 3. Replace the Holder shaft unit with new one. 4. Replace the Holder shaft unit with new one.
		Paper guide upper/left	1. Check if the Paper guide upper (only HP side) comes off from the Main frame.	1. Reassemble the Paper guide upper to the Main frame.
		Pump unit	1. Check if the Compression spring 1.764 comes off in the Change lever. 	1. Replace the Printer mechanism with new one.
	The LD roller is not set to the ASF home position and a paper is always loaded from ASF unit during the paper loading sequence.	Pump unit	1. Check if the tip of the Change lever is damaged.	1. Replace the Printer mechanism with new one.

Table 3-9. Check point for the paper out error according to each phenomenon

Occurrence timing CR position	Detailed phenomenon	Defective unit/part name	Check point	Remedy
Operation	The LD roller does not attempt to load a paper during the paper loading sequence. And also, the PF motor and the Spur gear 60 does not rotate at all.	Holder shaft unit *	1. Check if the Paper return plate disturbs the rotation of the LD roller. 	1. Reassemble the ASF unit to the printer.
		PF motor *	1. Check if the CR motor connector cable is connected to CN7 on the Main board. 2. Check if the coil resistance of the CR motor is about 6.0 ohm by using the tester. Refer to Table 3-1. 3. Check if the CR motor connector cable is damaged.	1. Connect the PF motor connector cable to CN7 on the Main board. 2. Replace the PF motor with new one. 3. Replace the PF motor with new one.
	The LD roller cannot pick up a paper, although the LD roller attempt to rotate correctly.	Holder shaft unit	1. Check if the any paper dust is adhered to the surface of the LD roller. 	1. Set a cleaning sheet in the ASF up side down. Then holding the top edge, try to load the paper from the Printer driver. The micro pearl on the LD roller surface is removed. To remove severe smear, staple a cloth moistened with alcohol to a post card and clean the roller in the same manner.  *If the problem is not solved, replace the Holder shaft unit with new one.

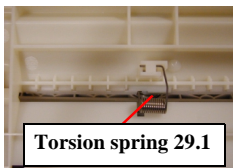
* When the Change lever is at the backside of the printer at power on timing, the printer can moves to the stand-by mode even if the PF motor does not rotate.

Table 3-10. Communication error condition and possible cause

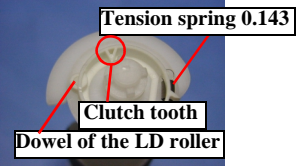
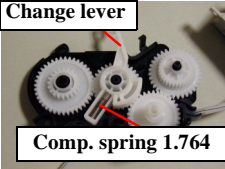
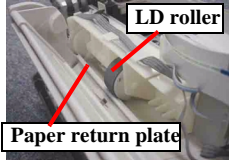
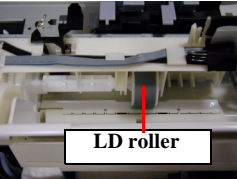
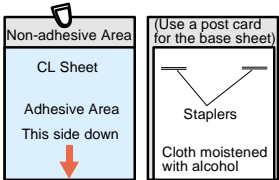
Error condition	LED indication STM3 message	Occurrence timing	CR position at the power on timing	Unit/Part name	Possible cause	Check table
Communication error	Power : Off Error : Off Communication error	Power on	Anywhere	Main board	The Main board is defective.	Refer to Table 3-11
				Power supply board	The Power supply connector cable comes off.	
					The Power supply connector cable is damaged.	
			The Power supply board is defective.			
		Operation	-	Main board	The incorrect data is stored into the specific address of the EEPROM.	
				Parallel cable	The parallel cable does not support the bi-directional transportation.	
Printer driver	The suitable printer driver is not installed into the PC.					

Table 3-11. Check point for the communication error according to each phenomenon

Occurrence timing CR position	Detailed phenomenon	Defective unit/part name	Check point	Remedy
Power on Anywhere	When turning on the power, the printer does not operate at all.	Power supply board	1. Check if the Power supply connector cable is connected to CN2 on the Main board. 2. Check if the Power supply connector cable is damaged.	1. Connect the Power supply connector cable to CN2 on the Main board. 2. Replace the Power supply board with new one. * If the problem is not solved, replace the Main board with new one.
Operation -	When turning on the power, the power on sequence is performed correctly. But, when any printer job is sent to printer, the communication error is indicated with STM3.	Main board	1. Check if the incorrect model name is stored into the 5F<H> address of the EEPROM on the Main board.	1. Write the 00<H> data into the 5F<H> address of the EEPROM by using the Dump eve. program in the Adjustment program.
		Parallel/USB cable	1. Check if the Parallel/USB cable is connected between the printer and the PC.	1. Connect the Parallel/USB cable to the printer and the PC.
		Printer driver	1. Check if the Stylus C60 printer driver is used for the printer job.	1. Install the Stylus C60 printer driver in the PC.

Table 3-12. Error condition before the initial ink charge/the I/C replacement CL and possible cause & Ink out error and possible cause

Error condition	LED indication * STM3 message	Occurrence timing	CR position at the power on timing	Unit/Part name	Possible cause	Check table	
Error before the initial ink charge is performed	Power : On Error : On	Power on	Inside HP	Ink cartridge	The 1st ink cartridge is defective.	Refer to Table 3-13	
	Incorrectly installed cartridge			Main board	The incorrect data is stored into the specific address of the EEPROM.		
Error before the ink replacement CL is performed	Power : On Error : On		Anywhere	Ink cartridge	2nd or more ink cartridges is defective.		
	Installed ink cartridge cannot be recognized				The ink cartridge is compatible or counterfeit one.		
	Power : On Error : On			Ink cartridge	The ink cartridge is defective.		
	Black & Color ink cartridge not installed				The ink cartridge is compatible or counterfeit one.		
Ink out error	Power : On Error : On	Ink cartridge	The ink amount in I/C is end condition.				
	Black & Color ink out		The ink cartridge is defective.				

* The above LED indication timing is at the CR home position. When the CR unit moves to the I/C replacement position with the I/C replacement sequence, this indication will change to blink condition.

Table 3-13. Check point for the error before the initial ink charge according to each phenomenon

Occurrence timing CR position	Detailed phenomenon	Defective unit/part name	Check point	Remedy
Power on Inside HP	The printer does not perform the initial ink charge and the error is indicated with LEDs and STM3.	Ink cartridge	1. Check if the ink cartridge can be used by install it to other printer.	1. Replace the ink cartridge with the brand-new one.
		Main board	1. Check if the incorrect data is stored into the 3C<H> address of the EEPROM on the Main board.	1. Write the 9E<H> data into the 3C<H> address of the EEPROM by using the Dump exe. program in the Adjustment program.

Table 3-13. Check point for the error before the initial ink charge according to each phenomenon

Occurrence timing CR position	Detailed phenomenon	Defective unit/part name	Check point	Remedy
Power on Anywhere	The printer does not perform the ink replacement CL and the error is indicated with LEDs and STM3.	Ink cartridge	1. Check if ink cartridge can be used by install it to other printer.	1. Replace the ink cartridge with brand-new one.
	The printer does not perform the printing operation and the error is indicated with LEDs and STM3.	Ink cartridge	1. Check if the ink is remaining in the I/C. 2. Check if the ink cartridge can be used by install it to other printer.	1. Replace the ink cartridge with brand-new one. 2. Replace the ink cartridge with brand-new one.

Table 3-14. Multiple papers are always loaded without LEDs and STM3

Error condition	LED indication STM3 message	Occurrence timing	CR position at the power on timing	Unit/Part name	Possible cause	Check table
Multiple papers are always loaded	Power : - Error : - No appear	Operation	-	ASF unit	The Tension spring 29.1 comes off.	Refer to Table 3-15

Table 3-15. Check point for multiple papers are always loaded without LEDs and STM3

Occurrence timing CR position	Detailed phenomenon	Defective unit/part name	Check point	Remedy
Operation -	Any error condition is not indicated with the LEDs and STM3. But, multiple papers are always loaded from ASF unit.	ASF unit	1. Check if the Paper return plate operates correctly in the paper loading sequence.	1. Reassemble the Tension spring 29.1 between the ASF frame and the Paper return plate. 

Table 3-16. Abnormal noise

Error condition	LED indication STM3 message	Occurrence timing	CR position at the power on timing	Unit/Part name	Possible cause	Check table
Abnormal noise	Power : - Error : - No appear	Anywhen	Anywhere	CR unit	The lubrication amount of the grease is insufficient.	Refer to Table 3-17
				Front frame	The Front frame is bent up.	
					The lubrication amount of the grease is insufficient.	
				Paper guide upper/left	The Paper guide upper/left comes off.	
Pump unit	The Change lever is not moved smoothly.					

Table 3-17. Check point for the abnormal noise

Occurrence timing CR position	Detailed phenomenon	Defective unit/part name	Check point	Remedy
Anywhen Anywhere	The abnormal noise occurs at the first power on timing and during each operation although the printing operation is performed.	CR unit	1. Check if the grease on the CR guide shaft is sufficient.	1. Wipe off the remaining grease on the CR guide shaft and lubricate it on its shaft.
		Front frame	1. Check if the grease on the Front frame is sufficient.	1. Wipe off the remaining grease on the Front frame and lubricate it on its frame.
		Pump unit	1. Check if the Change lever moves smoothly.	1. Replace the Printer mechanism with new one.
	The bottom of the CR unit contacts the surface of the Front frame.	Front frame	1. Check if the Front frame is bent up.	1. Replace the Front frame with new one.
	The CR unit collides to the Paper guide upper/left during each operation.	Paper guide upper/left	1. Check if the Paper guide upper/left comes off from the Main frame.	1. Reassemble the Paper guide upper/left to the Main frame.

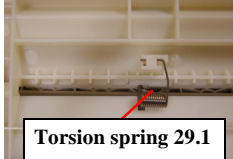
Table 3-18. Poor printing quality

Error condition	Occurrence timing	CR position at the power on timing	Phenomenon	Unit/Part name	Possible cause	Check table
Poor printing quality	Operation	-	Dot missing No printing Misalignment Mixed color	Cap unit	The seal rubber portion of the Cap has any foreign material or any damage.	Refer to Table 3-19
					The spring under the Cap comes off.	
					The Pump tube comes off from the bottom of the Cap.	
					The Extension spring 0.523 (for the Slider cap) comes off.	
					The Extension spring 0.383 (for the Slider lock lever) comes off.	
					The Slider lever is damaged.	
				Ink cartridge	The ink amount in I/C is end condition.	
			Main board	The Main board is defective.		
			Printhead	The Printhead has any foreign material on the nozzle surface.		
				The Printhead is defective.		
				The Head FFC is damaged.		
			Vertical banding against the CR movement direction	CR motor	The accuracy of the CR motor is lowered.	
				CR unit	The CR guide shaft has any stain or any damage.	
					The lubrication amount of the grease is insufficient.	
					The Torsion spring for the CR guide shaft comes off.	
The both I/C is not hold by the I/C cover securely.						
Front frame	The lubrication amount of the grease is insufficient.					
	The Front frame is bent up or down.					
Printhead	Each segment is printed correctly in the nozzle check pattern.					

Table 3-18. Poor printing quality

Error condition	Occurrence timing	CR position at the power on timing	Phenomenon	Unit/Part name	Possible cause	Check table	
Poor printing quality	Operation	-	Horizontal banding against CR movement direction	Lower housing	The porous pad for the “no margin” printing comes off.	Refer to Table 3-19	
				PF motor	The accuracy of the PF motor is lowered.		
				PF roller unit	The PF roller has any foreign material.		
					The PF roller is damaged		
					The Spur gear 60 is damaged.		
				Printer driver	The printer driver setting is not suitable.		
			Printhead	Each segment is printed correctly in the nozzle check pattern.			
			Star wheel mark	Front frame	The Front frame is bent down. The Star wheel comes off.		
				Paper eject roller unit	The Paper eject roller shaft comes off.		
			Insufficient top margin	LD roller unit	The friction of the LD roller is lowered.		
			Ink Blur	Printer driver	The printer driver setting is not suitable.		
				Printhead	The Head ID is not input correctly.		
			Ink stain	Front frame	The Front frame has the ink stain somewhere. The Front frame is bent up.		
					Lower housing		The Lower housing has the ink stain somewhere. The porous pad for the “no margin” printing comes off.
				Paper eject roller unit			The Paper eject roller has ink stain somewhere. The Spur gear 60 comes off.
					Paper guide upper/left		The Paper guide upper/left has ink stain somewhere.
				PF roller unit	The PF roller has ink stain somewhere.		
				Printhead	The Printhead has the ink drop on the nozzle surface. The Printhead cover has the ink drop.		
					Wrinkle		ASF unit

Table 3-19. Check point for the poor printing quality

Occurrence timing CR position	Detailed phenomenon	Defective unit/part name	Check point	Remedy
<p>Operation -</p>	<p>[Phenomenon 1] In the CL sequence, the Pump unit seems to work correctly. But, the ink is not ejected to the Waste drain ink pad at all. Moreover, any ink is not absorbed from the Printhead to the cap.</p> <p>[Phenomenon 2] In the CL sequence, the ink is ejected to the Waste drain ink pad (this means the Pump unit & the Cap unit works correctly). But, the dot missing is not solved at the specific nozzles even if the several CLs are performed.</p> <p>[Phenomenon 3] In the CL sequence, the ink is ejected to the Waste drain ink pad (this means the Pump unit & the Cap unit works correctly). But, the wiping operation is not performed correctly and the colors are mixed.</p> <p>[Phenomenon 4] In the CL sequence, the ink is ejected to the Waste drain ink pad. But, the dot missing occurs on the several nozzle in the printing.</p> <p>[Phenomenon 5] In the CL sequence, the ink is ejected to the Waste drain ink pad. But, the missing point (dot missing nozzle) is changed in every CL operation.</p>	<p>Cap unit</p>	<ol style="list-style-type: none"> 1. Check if there is any foreign material around the seal rubber parts on the Cap unit.  2. Check if any damage is observed around the seal rubber parts on the Cap unit. 3. Check if the Compression spring is assembled in the Cap unit correctly.  4. Check if the Pump tube is connected to the bottom of the Cap unit correctly  5. Check if the Extension spring 0.523 comes off from the Slider cap. 6. Check if the Extension spring 0.383 comes off from the Slider lock lever.  	<ol style="list-style-type: none"> 1. Remove the foreign material around the seal rubber parts carefully. <p>* The left figure is the cap for Stylus C20. The function of the Cap unit is the same although the cap size is different between Stylus C20 and Stylus Photo 810/820.</p> 2. Replace the Printer mechanism with new one. 3. Replace the Printer mechanism with new one. 4. Replace the Printer mechanism with new one. 5. Reassemble the Extension spring 0.523 correctly. 6. Reassemble the Extension spring 0.383 correctly.

Table 3-19. Check point for the poor printing quality

Occurrence timing CR position	Detailed phenomenon	Defective unit/part name	Check point	Remedy
Operation -	<p>[Phenomenon 6] In the CL sequence, the ink is ejected to the Waste drain ink pad. But, dot missing/misalignment occurs on all nozzle in the printing and is not solved in the several CLs.</p> <p>* If the problem solved, replace the Main board with new one.</p>	Cap unit	7. Check if the Slider lock lever is damaged.	7. Replace the Printer mechanism with new one.
	<p>Vertical banding appears against the CR movement direction. And, it looks like uneven printing.</p> <div data-bbox="415 842 575 1056" style="text-align: center;"> </div> <p>[Note] If the problem is not solved, replace the CR motor with new one.</p>	Ink cartridge	1. Check if the ink is remaining in the I/C.	1. Replace the ink cartridge with brand-new one.
Printhead	<ol style="list-style-type: none"> 1. Check if there is any foreign material on the nozzle surface of the Printhead. 2. Check if the Head FFC is connected to the CN4 on the Main board or Head FFC. 3. Check if the Head FFC is doggoned. 4. Check if each segment is printed correctly in the nozzle check pattern. 	<ol style="list-style-type: none"> 1. Perform the wiping operation. 2. Connect the Head FFC securely to the CN4 on the Main board or Printhead. 3. Replace the Head FFC with new one. 4. Perform the printhead cleaning and check the nozzle check pattern. If the problem is not solved, replace the printhead with new one. 		
CR unit	<ol style="list-style-type: none"> 1. Check if there is any foreign material on the surface of the CR guide shaft. 2. Check if any damage is observed on the surface of the CR guide shaft. 3. Check if the grease is enough on the surface of the CR guide shaft. <div data-bbox="1100 906 1335 1050" style="text-align: center;"> </div> <ol style="list-style-type: none"> 4. Check if the CR guide shaft is correctly set by the CR guide shaft rod springs to the Main frame. 5. Check if the ink cartridge is fixed by the ink cartridge cover. 	<ol style="list-style-type: none"> 1. Remove the foreign material around the seal rubber parts carefully. 2. Replace the CR guide shaft with new one. 3. Clean the surface of the CR guide shaft with the dry soft cloth and lubricate G-58 on its shaft. Refer to Figure 6-4. 4. Reassemble the CR shaft guide correctly. 5. Replace the ink cartridge cover with new one. 		

Table 3-19. Check point for the poor printing quality

Occurrence timing CR position	Detailed phenomenon	Defective unit/part name	Check point	Remedy
Operation	Vertical banding appears against the CR movement direction. And, it looks like uneven printing.	Front frame	1. Check if the grease is enough on the surface of the Front frame.  2. Check if the surface of the Front frame is flat.	1. Clean the surface of the Front frame with the dry soft cloth and lubricate G-58 on its shaft. Refer to Figure 6-6/Figure 6-7. 2. Replace the Front frame with new one.
		Printhead	1. Check if each segment is printed correctly in the nozzle check pattern.	1. Perform the printhead cleaning and check the nozzle check pattern. If the problem is not solved, replace the printhead with new one.
	Micro banding appears horizontally against the CR movement direction and it appears with the same width.  [Note] If the problem is not solved, replace the PF motor with new one.	PF roller unit	1. Check if there is any foreign material on the surface of the PF roller. 2. Check if the PF roller is damaged 3. Check if the Spur gear 60 is damaged.	1. Clean the surface of the PF roller carefully with the soft cloth. 2. Replace the Printer mechanism with new one. 3. Replace the Printer mechanism with new one.
		Printer driver & exclusive paper	1. Check if the suitable paper is used according to the printer driver setting.	1. Use the suitable paper according to the printer driver setting.
		Printhead	1. Check if each segment is printed correctly in the nozzle check pattern.	1. Perform the printhead cleaning and check the nozzle check pattern. If the problem is not solved, replace the printhead with new one.

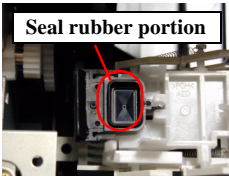
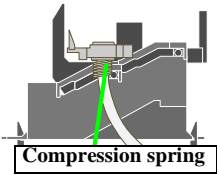
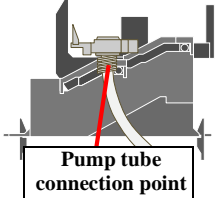
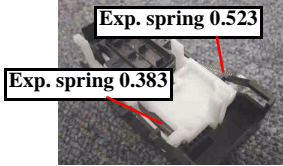
Table 3-19. Check point for the poor printing quality

Occurrence timing CR position	Detailed phenomenon	Defective unit/part name	Check point	Remedy
Operation	Banding * appears horizontally against the CR movement direction. 	Lower housing	1. Check if the porous pad in the Lower housing comes off.	1. Reassembly the porous pad correctly.
	* This banding is caused by the overlap of the printing path			
	Star wheel mark against the CR movement direction 	Front frame	1. Check if the Star wheel comes off. 2. Check if the surface of the Front frame is flat.	1. Reassemble the Star wheel correctly. 2. Replace the Front frame with new one.
	The printing operation is correctly performed. But, the top margin is insufficient than usual one.	Paper eject roller unit	1. Check if the Paper eject roller comes off from the Lower housing.	1. Reassemble the Paper eject roller correctly.
		LD roller unit	1. Check if the any paper dust is adhered to the surface of the LD roller. 	1. Set a cleaning sheet in the ASF up side down. Then holding the top edge, try to load the paper from the Printer driver. The micro pearl on the LD roller surface is removed. To remove severe smear, staple a cloth moistened with alcohol to a post card and clean the roller in the same manner. As for the cleaning sheet, refer to page 59 "Remedy of the Paper out error" *If the problem is not solved, replace the Holder shaft unit with new one.
Printing is blurred.	Printer driver & exclusive paper	1. Check if the suitable paper is used according to the printer driver setting.	1. Use the suitable paper according to the printer driver setting.	
	Printhead	1. Check if the correct Head ID is stored into the EEPROM by using the Adjustment program.	1. Input 11 digits code of the Head ID into the EEPROM by using the Adjustment program.	

Table 3-19. Check point for the poor printing quality

Occurrence timing CR position	Detailed phenomenon	Defective unit/part name	Check point	Remedy
Operation -	A paper stains with ink	Front frame	1. Check if the Front frame has the ink stain somewhere.	1. Clean the ink stain of the Front frame carefully with the soft cloth.
			1. Check if the Front frame is bent up.	1. Replace the Front frame with new one.
		Lower housing	1. Check if the Lower housing has the ink stain somewhere.	1. Clean the ink stain of the Lower housing carefully with the soft cloth.
			2. Check if the porous pad in the Lower housing comes off.	2. Reassembly the porous pad correctly.
		Paper eject roller unit	1. Check if the Paper eject roller has ink stain somewhere.	1. Clean the ink stain of the Paper eject roller carefully with the soft cloth.
			1. Check if the Spur gear 60 comes off.	1. Replace the Printer mechanism with new one.
		Paper guide upper/left	1. Check if the Paper guide upper/left has ink stain somewhere.	1. Clean the ink stain of the Paper guide upper/left carefully with the soft cloth.
	PF roller	1. Check if the PF roller has ink stain somewhere.	1. Clean the ink stain of the PF roller carefully with the soft cloth.	
Printhead	1. Check if the wiping operation is correct performed. 2. Check if the Printhead cover has the ink drop.	1. Replace the Printer mechanism with new one. 2. Clean the ink drop on the Printhead cover carefully with the soft cloth.		
	A top of a paper get wrinkled.	ASF unit	1. Check if the Hopper pad is correctly pasted on the dent of the Hopper. 2. Check if the LD pad is correctly pasted on the dent of the Paper return plate.	1. Replace the he Hopper pad with new one. 2. Replace the LD pad with new one.

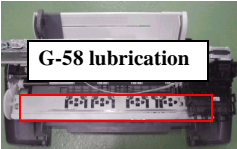
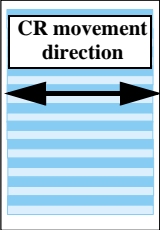
CHAPTER

4

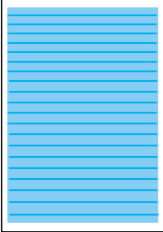
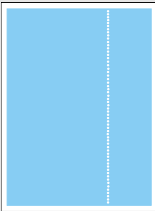
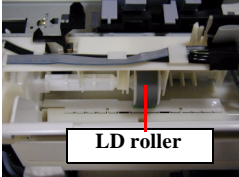
DISASSEMBLY AND ASSEMBLY

4.1 Overview

This section describes procedures for disassembling the main components of the Stylus C60. Unless otherwise specified, disassembly units or components can be reassembled by reversing the disassembly procedure. Things, if not strictly observed, that could result in injury or loss of life are described under the heading “Warning”. Precautions for any disassembly or assembly procedures are described under the heading “CAUTION”. Chips for disassembling procedures are described under the heading “CHECK POINT”.

If the assembling procedure is different from the reversed procedure of the disassembling, the procedure is described under the heading “REASSEMBLY”. Any adjustments required after reassembling the units are described under the heading “ADJUSTMENT REQUIRED”. When you have to remove any units or parts that are not described in this chapter, refer to the exploded diagrams in the appendix.

Read precautions described in the next section before starting.

4.1.1 Precautions

See the precautions given under the handling “WARNING” and “CAUTION” in the following column when disassembling or assembling EPSON Stylus C60.



- **Disconnect the power cable before disassembling or assembling the printer.**
- **If you need to work on the printer with power applied, strictly follow the instructions in this manual.**
- **Wear protective goggles to protect your eyes from ink. If ink gets in your eye, flush the eye with fresh water and see a doctor immediately.**
- **Always wear gloves for disassembly and reassembly to avoid injury from sharp metal edges.**
- **To protect sensitive microprocessors and circuitry, use static discharge equipment, such as anti-static wrist straps, when accessing internal components.**
- **Never touch the ink or wasted ink with bare hands. If ink comes into contact with your skin, wash it off with soap and water immediately. If irritation occurs, contact a physician.**
- **When a lithium battery is installed on the main board of this printer, make sure to observe the following instructions when serving the battery:**
 1. Keep the battery away from any metal or other batteries so that electrodes of the opposite polarity do not come in contact with each other.
 2. Do not heat the battery or put it near fire.
 3. Do not solder on any part of the battery. (Doing so may result in leakage of electrolyte from the battery, burning or explosion. The leakage may affect other devices close to the battery.)
 4. Do not charge the battery. (An explosion may be generated inside the battery, and cause burning or explosion.)
 5. Do not dismantle the battery. (The gas inside the battery may hurt your throat. Leakage, burning or explosion may also be resulted.)
 6. Do not install the battery in the wrong direction. (This may cause burning or explosion.)
- **Danger of explosion if the battery is incorrectly replaced. Replace only with the same or equivalent type recommended by the manufacture. Dispose the used batteries according to government’s law and regulations.**



- Avant de commencer, assurez vous que l'imprimante soit éteinte et que le cordon d'alimentation soit débranché.
- Lorsque vous changez la pile au lithium, assurez vous que la nouvelle respecte bien les caractéristiques requises.
- Lorsque que vous installez la pile au lithium, faites attention à l'insérer dans le bon sens en respectant la polarité.
- Veillez à jeter les piles usagées selon le règlement local.
- Ne rechargez pas les piles au lithium.



Risque d'explosion si la pile est remplacée incorrectement. Ne remplacer que par une pile du même type ou d'un type équivalent recommandé par le fabricant. Éliminer les piles déchargées selon les lois et les règles de sécurité en vigueur.



- Never remove the ink cartridge from the carriage unless this manual specifies to do so.
- When transporting the printer after installing the ink cartridge, be sure to pack the printer for transportation without removing the ink cartridge.
- Use only recommended tools for disassembling, assembling or adjusting the printer.
- Observe the specified torque when tightening screws.
- Apply lubricants and adhesives as specified. (See Chapter 6 for details.)
- Make the specified adjustments when you disassemble the printer. (See Chapter 5 for details.)
- When assembling, if an ink cartridge is removed and needs to be installed again, be sure to install a new ink cartridge because of the following reasons;
 1. Once the ink cartridge mounted on the printer is removed, air comes in and creates bubbles in the cartridge. These bubbles clog ink path and cause printing malfunction.
 2. If an ink cartridge in use is removed and is reinstalled, ink quantity will not be detected correctly since the counter to check ink consumption is cleared.
- Because of the reasons above, make sure to return the printer to the user with a new ink cartridge installed.
- Make sure the tip of the waste ink tube is located at correct position when reassembling the waste ink tube. Otherwise it will cause ink leakage.

4.1.2 Tools







Use only specified tools to avoid damaging of the printer.

Table 4-1. Tools

Name	Supplier	Parts No.
Phillips Screw Driver (No.1)	EPSON	B743800100
Phillips Screw Driver (No.2)	EPSON	B743800200
Nipper	EPSON	B740500100
Tweezers	EPSON	B741000100
POM Puller	EPSON	2035659 (#F749)
Hexagon Box Driver (Opposite side : 5.5 mm)	EPSON	B741700100

4.1.3 Screws

Table 4-2. Screws

No	Name and specification	Outward form	pcs
1	C.B.S. SCREW, 3 x 6, F/Zn		10
2	C.C.S-TITE SCREW, 3 x 6, F/Zn		1
3	C.B.P-TITE SCREW, 3 x 8, F/Zn		3
4	C.B.S. SCREW, 3 x 14, F/Zn		2
5	C.B.S-TITE (P4), 3 x 6, F/Zn		1
6	+BIND B-TITE SEMS W2, 2.5 X 5, F/Zb		1
7	C.B.(O). SCREW, 4 x 5, F/Zg		1
8	C.B.P-TITE SCREW, 3 x 10, F/Zn		1

4.1.4 Work Completion Check

If any service is made to the printer, use the checklist shown below to confirm all works are completed properly and the printer is ready to be returned to the user.

Table 4-3. Work Completion Check

Classification	Item	Check Point	Status	
Main Unit	Self-test	Is the operation normal?	<input type="checkbox"/> Checked <input type="checkbox"/> Not necessary	
	On-line Test	Is the printing successful?	<input type="checkbox"/> Checked <input type="checkbox"/> Not necessary	
	Printhead	Is ink discharged normally from all the nozzles?	<input type="checkbox"/> Checked <input type="checkbox"/> Not necessary	
	Carriage Mechanism		Does it move smoothly?	<input type="checkbox"/> Checked <input type="checkbox"/> Not necessary
			Is there any abnormal noise during its operation?	<input type="checkbox"/> Checked <input type="checkbox"/> Not necessary
			Is there any dirt or foreign objects on the CR Guide Shaft?	<input type="checkbox"/> Checked <input type="checkbox"/> Not necessary
			Is the CR Motor at the correct temperature? (Not too heated?)	<input type="checkbox"/> Checked <input type="checkbox"/> Not necessary
	Paper Feeding Mechanism		• Is paper advanced smoothly?	<input type="checkbox"/> Checked
			• No paper jamming?	<input type="checkbox"/> Not necessary
			• No paper skew?	
			• No multiple feeding?	
			• No abnormal noise?	
			Is the PF Motor at correct temperature?	<input type="checkbox"/> Checked <input type="checkbox"/> Not necessary
			Is the paper path free of any obstructions?	<input type="checkbox"/> Checked <input type="checkbox"/> Not necessary
Adjustment	Specified Adjustment	Are all the adjustment done correctly?	<input type="checkbox"/> Checked <input type="checkbox"/> Not necessary	

Table 4-3. Work Completion Check

Classification	Item	Check Point	Status
Lubrication	Specified Lubrication	Are all the lubrication made at the specified points?	<input type="checkbox"/> Checked <input type="checkbox"/> Not necessary
		Is the amount of lubrication correct?	<input type="checkbox"/> Checked <input type="checkbox"/> Not necessary
Function	ROM Version	Version:	<input type="checkbox"/> Checked <input type="checkbox"/> Not necessary
Packing	Ink Cartridge	Are the ink cartridges installed correctly?	<input type="checkbox"/> Checked <input type="checkbox"/> Not necessary
	Protective Materials	Have all relevant protective materials been attached to the printer?	<input type="checkbox"/> Checked <input type="checkbox"/> Not necessary
Others	Attachments, Accessories	Have all the relevant items been included in the package?	<input type="checkbox"/> Checked <input type="checkbox"/> Not necessary

4.2 Disassembly

The flowchart below shows step-by-step disassembly procedures. When disassembling each unit, refer to the page number shown in the figure.

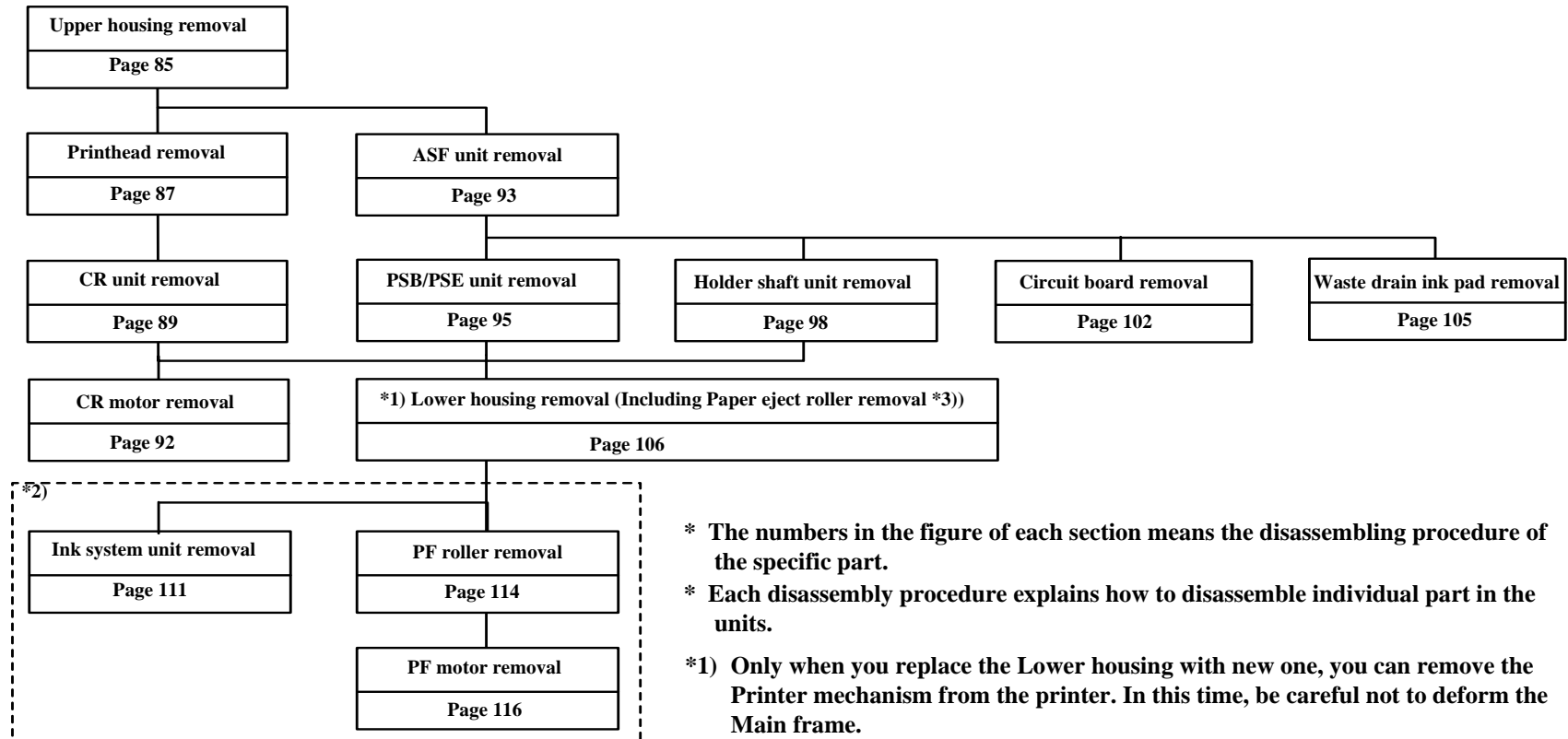

* The numbers in the figure of each section means the disassembling procedure of the specific part.

* Each disassembly procedure explains how to disassemble individual part in the units.

*1) Only when you replace the Lower housing with new one, you can remove the Printer mechanism from the printer. In this time, be careful not to deform the Main frame.

*2) We recommend to replace to new Printer mechanism with the Lower housing to avoid the Main frame deformation by removing a part on the Printer mechanism without the Lower housing (These units are not established for the service part individually). However, the these procedures should be followed in the urgent case. In this time, the disassembly procedure is different depending on the removed unit.

* Ink system unit : ASF unit, CR unit, PSB/PSE unit, Holder shaft unit, Lower housing

* PF roller/PF motor : ASF unit, CR unit, PSB/PSE unit, Lower housing

*3) Unlike the paper eject roller shaft for the Stylus C60, there is not two hooks on the paper eject roller shaft for the Stylus Photo 810/820. So, you can remove it from the Printer mechanism. However, you cannot replace it to new one because its roller shaft is not established for service part.

Figure 4-1. Disassembling flowchart

4.2.1 Upper housing removal

1. Move the Edge guide on the ASF unit to the rightmost position.

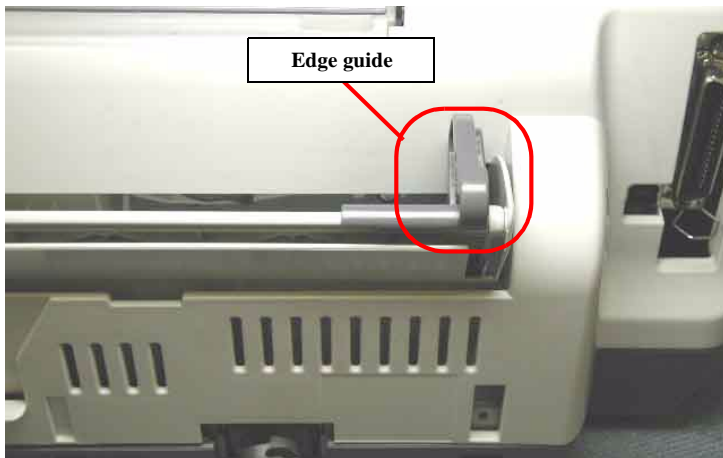

Figure 4-2. Edge guide setting position for the Lower housing removal



- Make sure that the Edge guide is in the cutout portion of the Upper housing.

2. Release total seven hooks of the Upper housing by using the precision screwdriver (-).

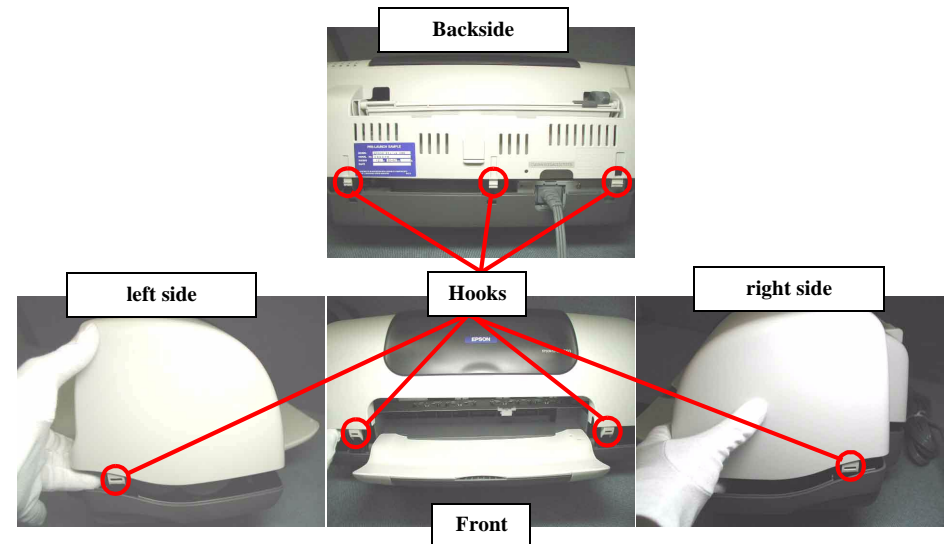

Figure 4-3. Hooks position of the Upper housing



- Do not damage hooks by the precision screwdriver (-) in removing the Upper housing.
- Do not tilt the printer too much when the Upper housing is removed by the precision screwdriver (-). This is because ink may flow if the cap is not covered by the Printhead. (CR is out of the home position)

3. Move the protrusion of the Upper housing, which contacts USB interface, to the right side slightly by using the precision screwdriver (-).

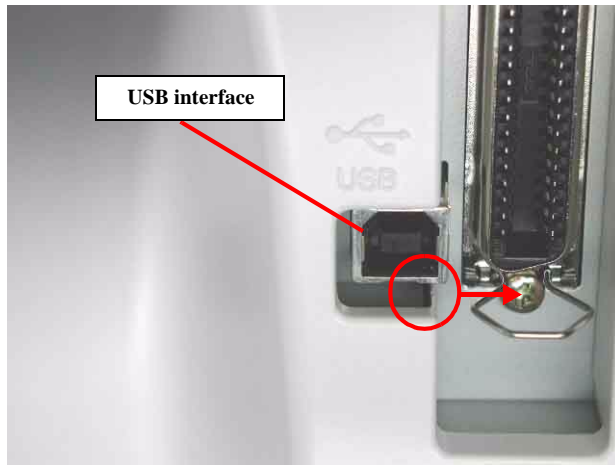

Figure 4-4. Protrusion position of the Upper housing



- Do not damage the protrusion by the precision screwdriver (-).



- When assembling the Upper housing to the printer,
 - Make sure that the lower metal fittings for locking the Parallel interface is on the Housing.
 - Make sure that seven hooks of the Upper housing is correctly fixed to the Lower housing.
 - Make sure that there is not the clearance between the Upper housing and the Lower housing.

4.2.2 Printhead removal

1. Remove the Upper housing from the printer. (Refer to Section 4.2.1)
2. Open the Cover cartridge, and remove the both black and color ink cartridges.
3. Remove the both Cover cartridges from the CR unit.
4. Release two hooks for securing the Head FFC holder, and remove the Head FFC holder from the CR unit.

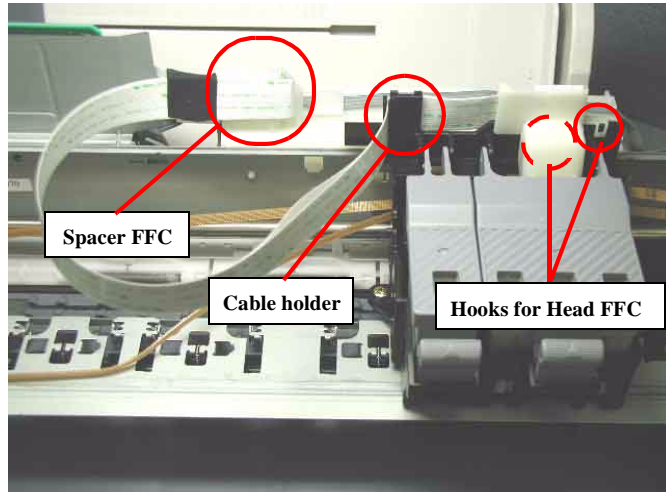

Figure 4-5. Head FFC holder removal

5. Remove two screws (C.B.P-TITE SCREW 3x8 F/Zn, +BIND B-TITE SEMS W2 2.5x5 F/Zb) for tightening the Printhead, and remove the Printhead from the CR unit in the order indicated in the following figure.

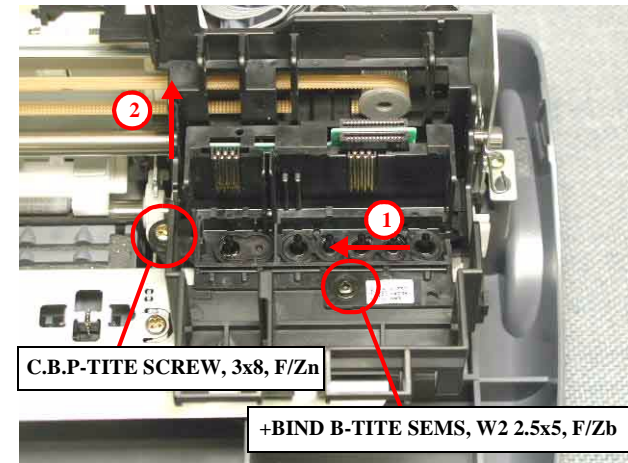

Figure 4-6. Printhead removal

6. Disconnect the Head FFC from the connector on the Printhead.



- When assembling the Printhead to the CR unit,
 - Make sure to place the Head FFC on the Spacer FFC and the cable holder on the left side of the CR unit. (Refer to Figure 4-5)
 - Make sure to install the Head grounding plate to the carriage correctly.

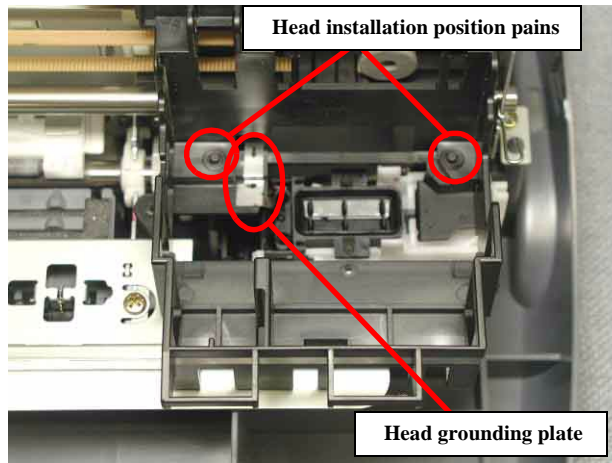

Figure 4-7. Printhead installation position (pin & the grounding plate)

- Make sure to fit two holes of the Printhead to the installation position pins correctly. (Refer to Figure 4-7)
- Fastening two screw (C.B.P-TITE SCREW 3x8 F/Zn, +BIND B-TITE SEMS W2 2.5x5 F/Zb) for securing the Printhead to the CR unit.

Tightening Torque for each screw is as follows.

- C.B.P-TITE SCREW, 3 x 8, F/Zn (1 pcs) : 6 ± 1 kgf.cm
- +BIND B-TITE SEMS, W2, 2.5 x 5, F/Zb (1 pcs) :
: 2 ± 0.5 kgf.cm

- When assembling the Head cable holder to the CR unit,
 - Make sure to place the Head FFC in the correct position.

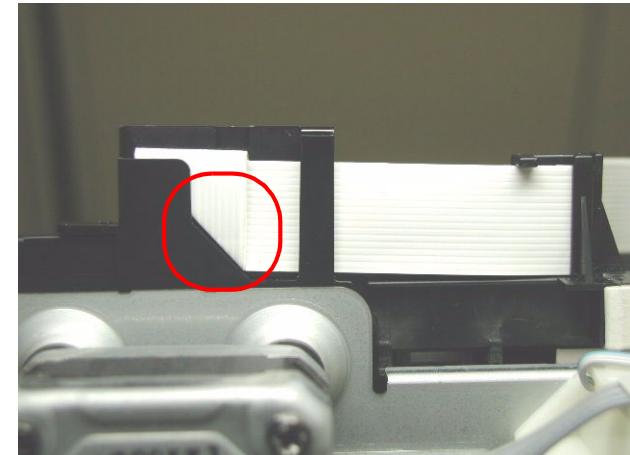

Figure 4-8. Head FFC setting position

- Make sure that the Head FFC is connected to the Printhead correctly.
- Make sure that the Head cable holder is correctly fixed.



- When the Printhead is replaced with new one, the following adjustments must be performed in the order below.
 - 1) Initial ink charge
 - 2) Head ID input
 - 3) Gap adjustment (Bi-d adjustment)
 - 4) Top margin adjustment
 - 5) 1st dot position adjustment
- When the Printhead is removed and reinstalled, only the following adjustment is required.
 - 1) Printhead cleaning
 - 2) Gap adjustment (Bi-d adjustment)
 - 3) Top margin adjustment
 - 4) 1st dot position adjustment

4.2.3 CR unit removal

1. Remove the Upper housing from the printer. (Refer to Section 4.2.1)
2. Release the change lever toward the backside of the printer by using the tweezers, and move the CR unit from the CR home position to around the center position.
3. Loosen the CR timing belt by pushing the Driven pulley holder to the right side, and remove the CR timing belt carefully from the CR motor pinion gear.

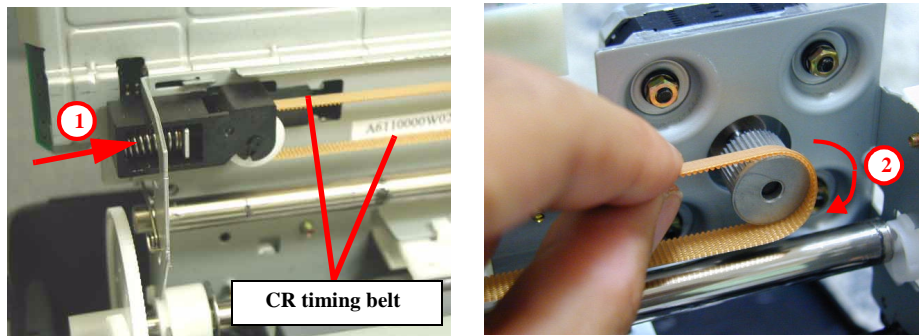

Figure 4-9. CR timing belt removal

4. Remove the Compression spring 19.6 from the Driven pulley holder by using the tweezers.

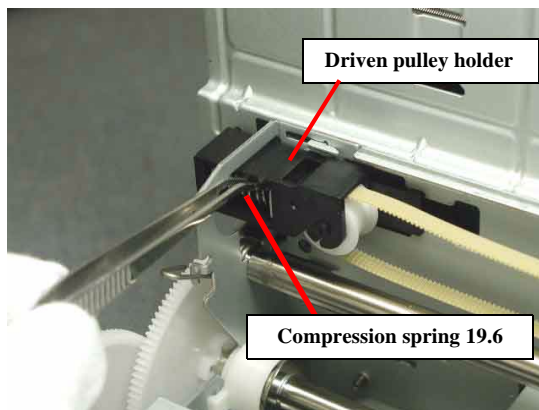

Figure 4-10. Compression spring 19.6 removal

5. Slide the Driven pulley holder to the right side, and remove it forward.
6. Release the Head FFC from the Spacer FFC on the LD roller shaft holder, and disconnect the Head FFC from the connectors (CN8, CN9) on the Main board. (Refer to Figure 4-5)
7. Release two CR guide shaft rod springs from the hooks on the left and right side of the Main frame.

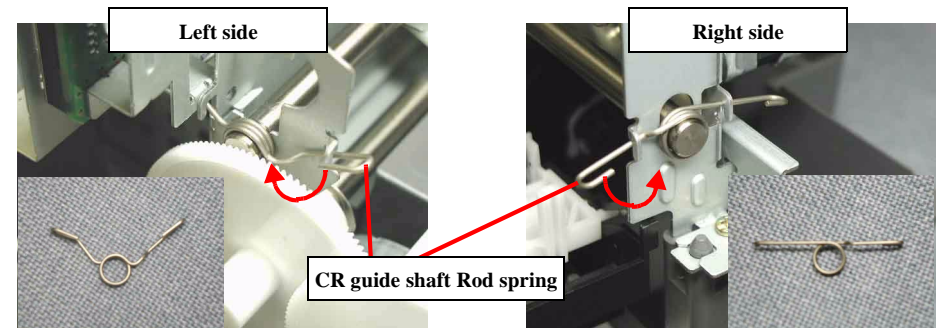

Figure 4-11. CR guide shaft rod spring release



- In this step, you cannot remove the left CR guide shaft rod spring from the CR guide shaft even if it is released from the Main frame. So, when sliding the CR guide shaft in the next step, remove the left CR guide shaft rod spring carefully.

8. Pull the left end of the CR guide shaft upward, and slide the CR guide shaft to the right side while holding the CR unit by hand.

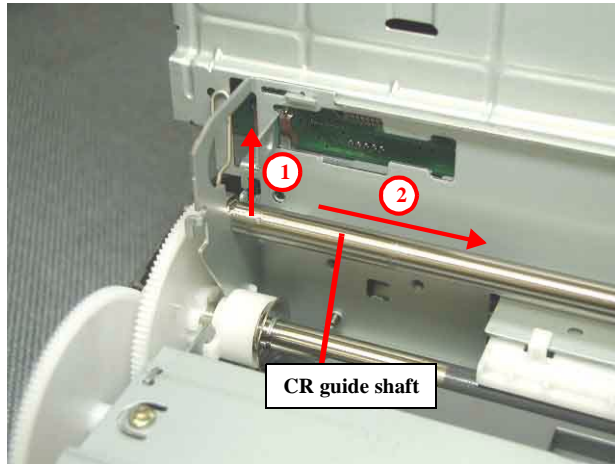

Figure 4-12. CR unit removal

9. Remove the CR guide shaft along with the CR unit by sliding it to the left or right.



- ❑ Remove the CR guide shaft while holding the CR unit by hand. If you remove the CR guide shaft without holding the CR unit, the nozzle surface of the Printhead may come in contact with the Paper guide front, which causes the dot missing problem.
- ❑ Do not use the removed the Pulley driven holder to other printer. (The interchangeability has not been kept completely between the Pulley driven holder depending on the manufacture.)



- ❑ Unlike the previous printer (Stylus COLOR 680), the oil pad is not built in the CR unit.
- ❑ If you remove the Printhead from the CR unit, make sure that the Head grounding plate is set in the CR unit. (Refer to Figure 4-7)
- ❑ If the CR unit is disassembled or replaced with new one, make sure that the CR timing belt is set in the assembling groove correctly as the following figure.

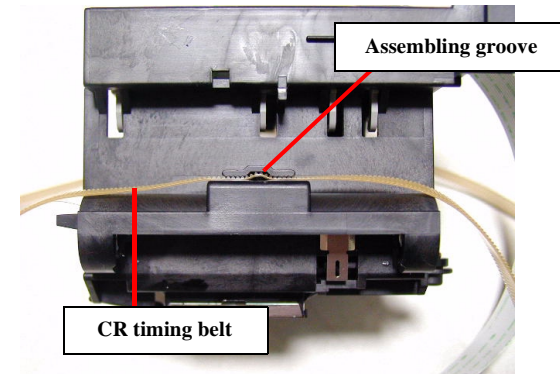

Figure 4-13. CR timing belt setting position



- When assembling the CR unit to the printer,
 - Make sure to install the CR grounding plate in the CR unit.

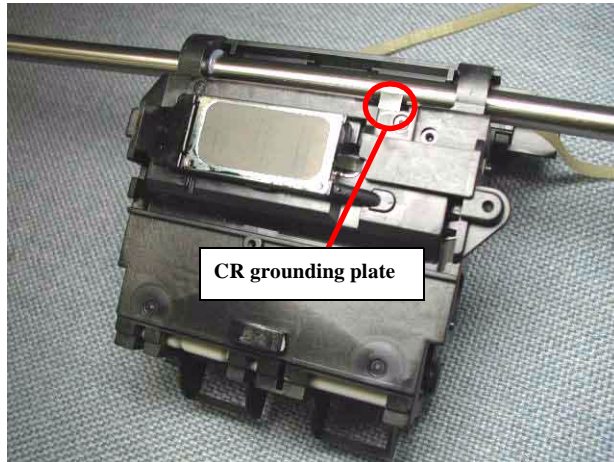

Figure 4-14. Grounding plate assembling position

- When assembling the CR timing belt to the carriage,
 - Do not stain the CR timing belt with the grease (G-58).
- When assembling the Pulley driven holder to the Main frame,
 - Make sure to set the Compression spring 19.6 correctly.
- When assembling the CR unit to the Main frame,
 - Do not touch the lubrication area of the CR guide shaft.
 - Make sure that two CR guide shaft rod springs is correctly fixed. (Refer to Figure 4-11)
 - Make sure that the CR unit moves smoothly.

- Set the left CR guide shaft rod spring between the Spur gear 60 and the Main frame before installing the CR guide shaft with the CR unit to the printer. And, install the groove of the CR guide shaft to the cutout portion of the Main frame after passing the left end of the CR guide shaft through the CR guide shaft rod spring.

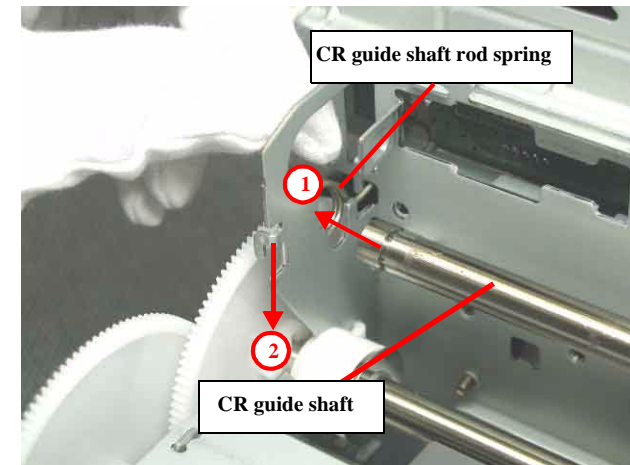

Figure 4-15. CR guide shaft rod spring setting procedure



- When you replace the CR unit with new one, lubricate it with the suitable amount of the G-58 grease by the specified position. (Refer to Figure 6-4 in the Chapter 6.)
- When you replace the Pulley driven shaft with new one, lubricate it with the suitable amount of G-58 grease by the specific position. (Refer to Figure 6-9 in the Chapter 6.)
- When you replace the Pulley driven holder with new one, lubricate it with the suitable amount of G-58 grease by the specific position. (Refer to Figure 6-5 in the Chapter 6.)
- When removing or replacing the CR unit with new one, the following adjustment must be performed in the order below.
 - 1) Gap adjustment (Bi-d adjustment)
 - 2) Top margin adjustment
 - 3) 1st dot position adjustment

4.2.4 CR motor removal

1. Remove the Upper housing from the printer. (Refer to Section 4.2.1)
2. Remove the CR unit from the printer. (Refer to Section 4.2.3)
3. Disconnect the CR motor connector cable from the connector (CN12) on the Main board, and release the CR motor connector cable from five hooks on the LD roller shaft holder.
4. Remove four nuts (HEXAGON NOT NORMAL M3) for securing the screw of the CR motor while holding the CR motor by hand.



- When the CR motor is removed or replaced with new one, the following adjustment must be performed in the order below.
- 1) Gap adjustment (Bi-d adjustment)
 - 2) 1st dot position adjustment



- When assembling the CR motor to the Main frame,
- Make sure to connect the CR motor connector cable to the connector (CN12) on the Main board.
 - Fasten four Hexagon nut (HEXAGON NUT NORMAL M3) for securing the CR motor in the order indicated in the following figure.

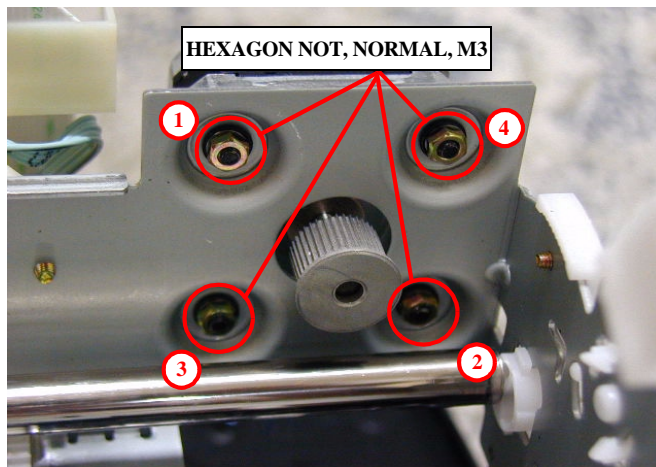

Figure 4-16. CR motor assembling

Tightening torque for the CR motor hexagon nut is as follows.

- HEXAGON NUT, NORMAL, M3 (4 pcs) : 6 ± 1 kgf.cm
- Make sure that the CR motor is correctly fixed.

4.2.5 ASF unit removal

1. Remove the Upper housing from the printer. (Refer to Section 4.2.1)
2. Remove three screws (C.B.S. SCREW 3x6 F/Zn, C.B.S-TITE (P4) 3x6 F/Zn, C.B.P-TITE 3x8 F/Zn) for securing the ASF unit to the Main frame, and remove the ASF unit with pulling up slightly to the backside of the printer..

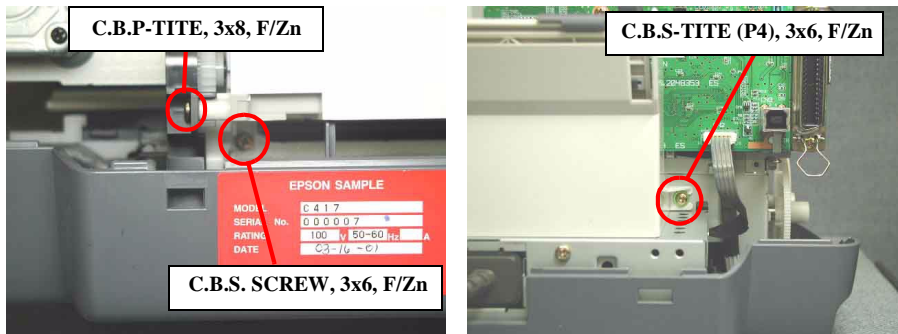

Figure 4-17. Screw position for removing the ASF unit

3. Remove the Compression spring 2.50 located between the ASF frame and the Hopper, and remove the Hopper from the ASF unit.

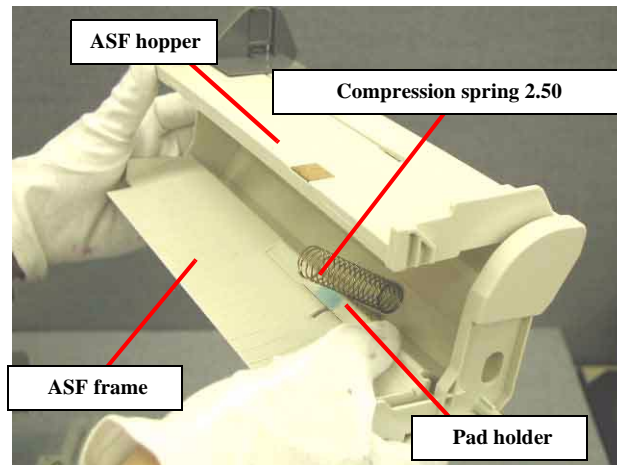

Figure 4-18. Compression spring 2.50 and the Hopper removal

4. Remove the Torsion spring 29.1 from the bottom of the ASF frame and the Pad holder (Paper return plate).

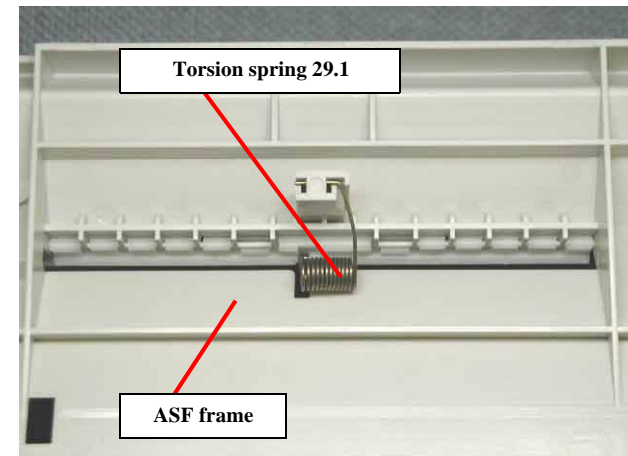

Figure 4-19. Torsion spring 29.1 setting position



- When assembling the LD pad on the Pad holder and the Hopper pad on the Hopper,
 - Make sure to place it inside the square dent.

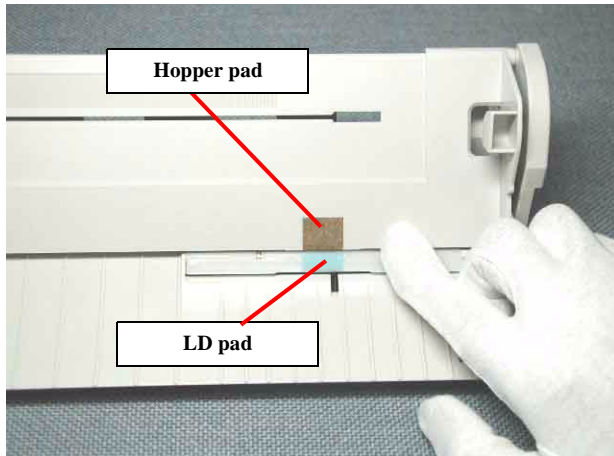

Figure 4-20. Hopper pad and LD pad setting position

- Do not touch the surface of these pads.
- Do not reuse the pad which you miss to stick.
- When assembling the Pad holder to the ASF frame,
 - Make sure to install the tip of the Torsion spring 29.1 in the holes of the Pad holder and the ASF frame.
 - Make sure that the Pad holder (Paper return plate) moves smoothly.

- When assembling the ASF unit to the printer,
 - Make sure that the LD roller is set to the ASF home position.
 - Fasten three screws (C.B.S. SCREW 3x6 F/Zn, C.B.S-TITE (P4) 3x6 F/Zn, C.B.P-TITE 3x8 F/Zn) for securing the ASF unit in the order indicated in the following figure.

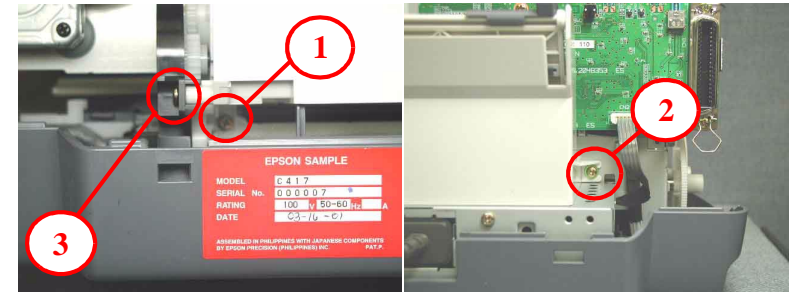

Figure 4-21. ASF fixing screws fastening order

Tightening torque for each screw is as follows.

- C.B.S. SCREW, 3x6, F/Zn (1 pcs) : 9 ± 1 kgf.cm
- C.B.S-TITE (P4), 3x6, F/Zn (1 pcs) : 9 ± 1 kgf.cm
- C.B.P-TITE, 3x8, F/Zn (1 pcs) : 6 ± 1 kgf.cm



- When the CR motor is removed or replaced with new one, the following adjustment must be performed in the order below.
 - 1) Top margin adjustment
 - 2) 1st dot position adjustment

4.2.6 PSB/PSE unit removal

1. Remove the Upper housing from the printer (Refer to Section 4.2.1).
2. Remove the ASF unit from the printer (Refer to Section 4.2.5)
3. Disconnect the Power supply connector cable (CN2) from the Main board.
4. Remove two screws (C.B.S. SCREW 3x6 F/Zn, C.B.P-TITE SCREW 3x8 F/Zn) for securing the PSB/PSE unit to the printer, and remove the PSB/PSE unit with pulling toward the backside of the printer.

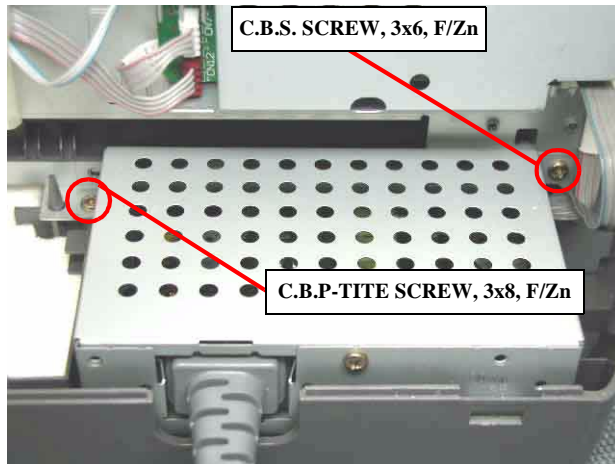

Figure 4-22. PSB/PSE unit removal

5. Remove one screw (C.B.S. SCREW 3x6 F/Zn) for securing the Upper power supply board shield plate, and remove the Upper power supply board shield plate.

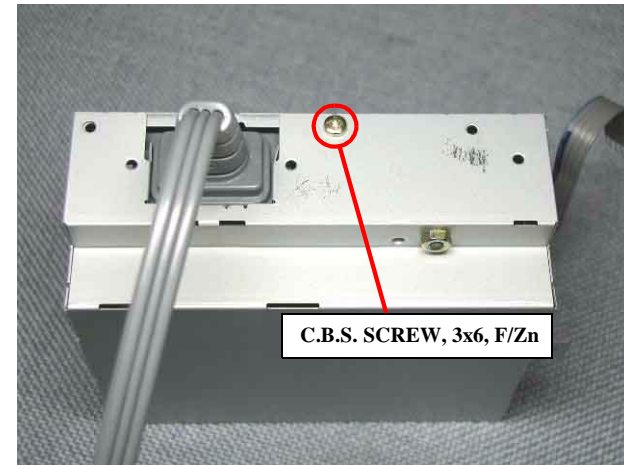

Figure 4-23. Upper power supply board shield plate removal

6. Remove three screws (C.B.S. SCREW 3x6 F/Zn, C.C.S-TITE SCREW 3x6 F/Zn) for securing the Power supply board, and remove one screw (C.B.(O). SCREW 4x5 F/Zg) for the earth wire.

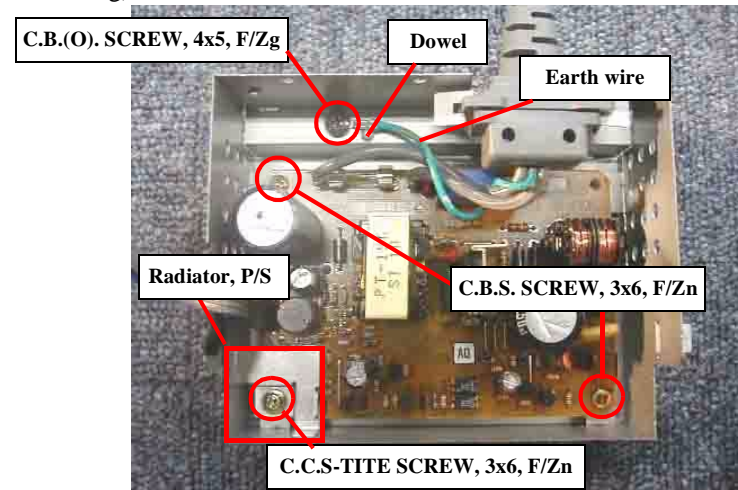

Figure 4-24. Power supply board removal

7. Remove the Upper power supply board from the Lower power supply board shield plate.



- When assembling the Power supply board to the Lower power supply board shield plate,
 - Make sure to install the Power supply board correctly.
 - Fasten three screws (C.B.S. SCREW 3x6 F/Zn, C.C.S-TITE SCREW 3x6 F/Zn, C.B.(O). SCREW 4x5 F/Zg) for securing the Power supply board and the earth wire to the Lower power supply board shield plate in the order indicated in the following figure.

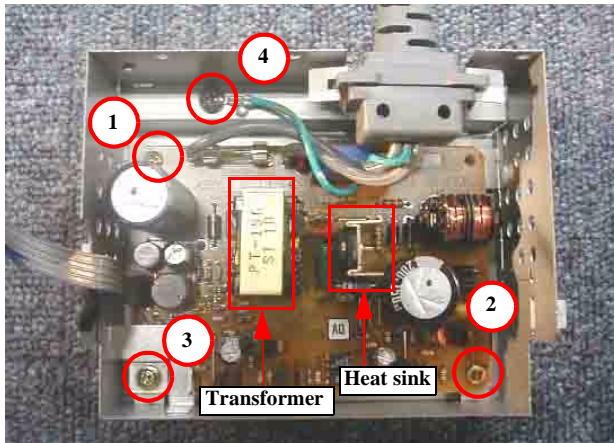

Figure 4-25. Tightening procedure for the PSB/PSE board

Tightening torque for each screw is as follows.

- C.B.(O). SCREW, 4x5, F/Zg (1 pcs) : 11 ± 1 kgf.cm
- C.B.S. SCREW, 3x6, F/Zn (2 pcs) : 6 ± 1 kgf.cm
- C.B.S-TITE SCREW, 3x6, F/Zn (1 pcs) : 6 ± 1 kgf.cm
- Make sure to place three wires of the AC cable away from the Transformer and the Heart sink on the Power supply board. (Refer to Figure 4-25)

- Make sure to set the Power supply radiator in the correct position. (Refer to Figure 4-25)
- Make sure to set the earth wire on the dowel of the Lower power supply board shield plate (Refer to Figure 4-24) (* The product with 110V type AC cable does not have the earth line)

- When assembling the Upper power supply shield plate to the Lower power supply shield plate,
 - Make sure to place the Power supply connector cable in the space between both power supply shield plates.

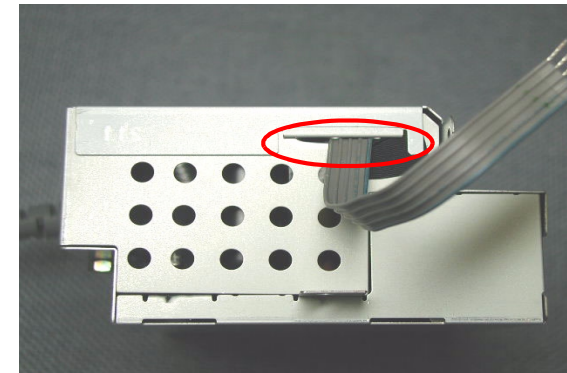

Figure 4-26. Power supply connector cable setting position



- Fasten one screw (C.B.S. SCREW 3x6 F/Zn) for securing the Upper power supply shield plate to the Lower power supply shield plate. (Refer to Figure 4-23)

Tightening torque for screw is as follows.

- C.B.S. SCREW, 3x6, F/Zn (1 pcs) : 6 ± 1 kgf.cm

- When assembling the PSB/PSE unit to the Lower housing,
 - Make sure to set the PSB/PSE unit under the protrusion of the Lower housing.

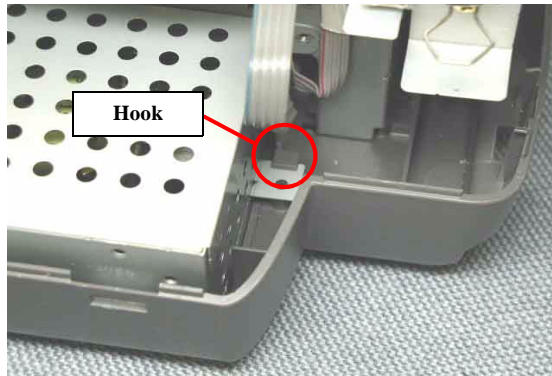

Figure 4-27. Power supply board shield plate setting position

- Make sure to connect the Power supply connector cable to the connector (CN2) on the Main board.
- Fasten two screws (C.B.P-TITE SCREW 3x8 F/Zn, C.B.S. SCREW 3x6 F/Zn) for securing the PSB/PSE unit to the Lower housing. (Refer to Figure 4-22)

Tightening torque for each screw is as follows.

- C.B.P-TITE SCREW, 3x8, F/Zn (1 pcs) : $6 + 1$ kgf.cm
- C.B.S. SCREW, 3x6, F/Zn (1 pcs) : $6 + 1$ kgf.cm

4.2.7 Holder shaft unit removal

1. Remove the Upper housing from the printer. (Refer to Section 4.2.1)
2. Remove the ASF unit from the printer (Refer to Section 4.2.5)
3. Release the Head FFC from the Spacer FFC on the LD roller shaft holder.

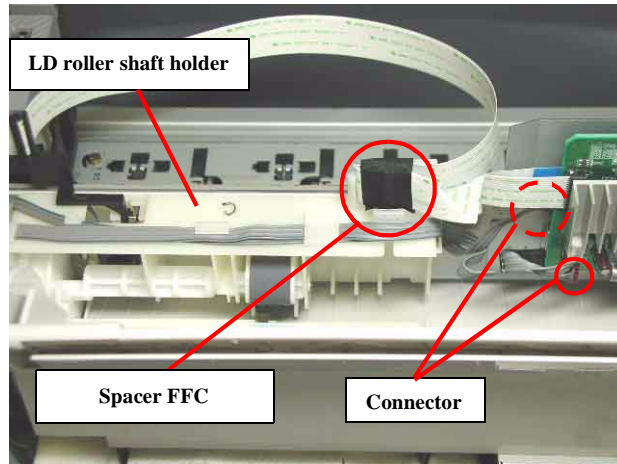

Figure 4-28. Head FFC removal

4. Disconnect the CR motor connector cable and the HP/PE Sensor cable from the connectors (CN4, CN12) on the Main board.
5. Release the CR motor connector cable from five hooks on the LD roller shaft holder.
6. Release the Change lever toward the backside of the printer by using the tweezers, and move the CR unit to the leftmost side (far side).
7. Push two hooks of the LD roller shaft holder, and pull the Holder shaft unit upward slightly from the Main frame. (Step1, 2 in the Figure 4-29)

8. Move the Pump unit to the right side slightly while holding the whole of the Holder shaft unit, and pull the bottom of the Holder shaft unit toward the backside of the printer. (Step 3 in the Figure 4-29)

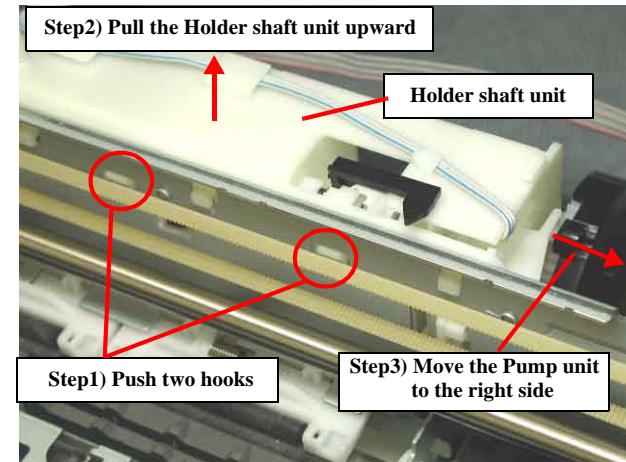

Figure 4-29. LD roller shaft holder removal

9. Remove the LD roller shaft along with the Clutch mechanism from the LD roller shaft holder.

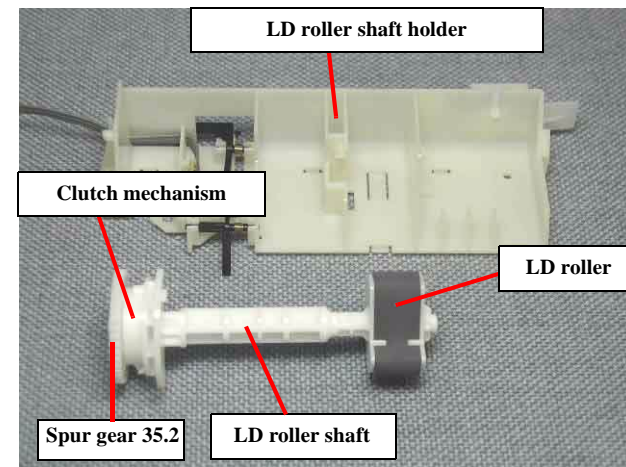

Figure 4-30. LD roller with Clutch mechanism removal

10. Remove the Spur gear 35.2 from the LD roller shaft.
11. Remove the Compression spring, 0.143, and remove the Clutch from the LD roller shaft.
12. Release one hook for securing the HP/PE sensor, and push the HP/PE sensor from the side contacting the Main frame by using the tweezers.

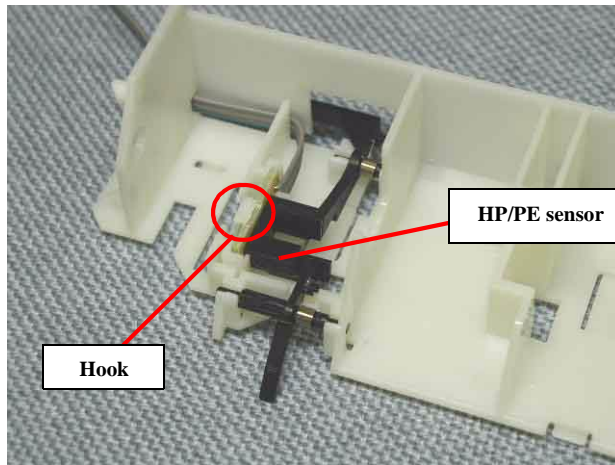

Figure 4-31. HP/PE sensor removal

13. Remove the Torsion spring 0.22 for the HP/PE detection levers, and remove the these levers from the LD roller shaft holder.



- When assembling the HP/PE detection lever to the LD roller shaft holder,
 - Make sure to set the Torsion spring 0.22 for the HP/PE detection levers to the following suitable position.

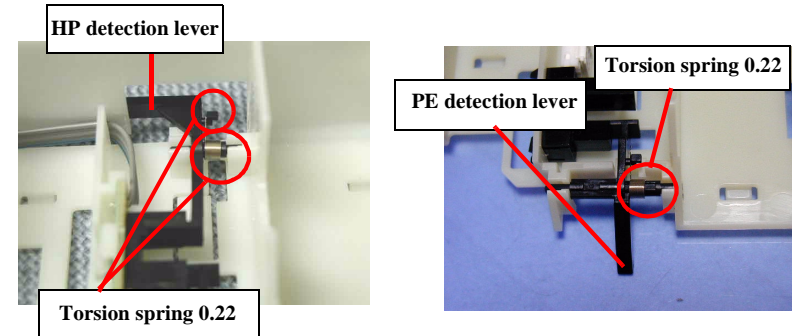

Figure 4-32. Torsion spring 0.22 for each detection lever

- Make sure that the HP/PE detection lever moves smoothly.
- When assembling the HP/PE sensor to the LD roller shaft holder,
 - Make sure that the HP/PE sensor is correctly fixed by the hook of the LD roller shaft holder.
 - Make sure to place the HP/PE sensor cable to the suitable groove on the LD roller shaft holder.

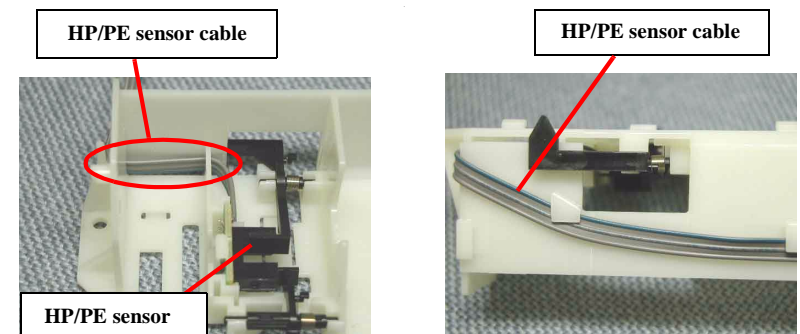

Figure 4-33. HP/PE sensor cable placing position



- When assembling the Clutch mechanism to the LD roller shaft,
 - Make sure to set the round hole of the Clutch on the dowel of the LD roller shaft.

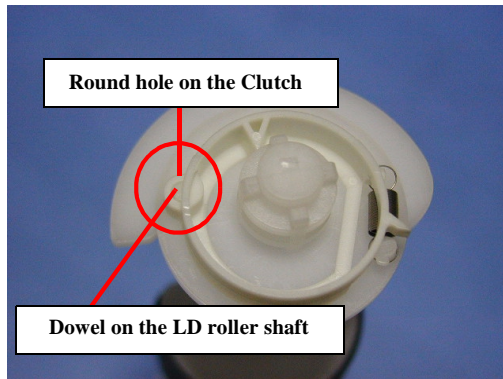

Figure 4-34. Clutch assembling

- Make sure to set the Tension spring 0.143 to the hooks of the Clutch and the LD roller shaft.
- Make sure that the Clutch rotates properly.
- When assembling the LD roller shaft to the LD roller shaft holder,
 - Do not touch the LD roller.
- When assembling the Spacer FFC on the Holder shaft unit,
 - Make sure to place the Head FFC in the correct position. (Refer to Figure 4-28)
- When assembling the Holder shaft unit to the Main frame,
 - Make sure that five hooks and three dowels of the Holder shaft unit is correctly fixed.
 - Make sure to place the HP/PE sensor cable, CR motor connector cable and the Head FFC on the Holder shaft unit.
 - Make sure to connect the HP/PE sensor cable, CR motor connector cable and the Head FFC to the connector (CN4, CN8, CN9, CN12) on the Main board.

- Do not touch the LD roller.
- Do not damage the tooth of the Spur gear 35.2 and the Combination gear 16.32 when assembling the Holder shaft unit to the printer.

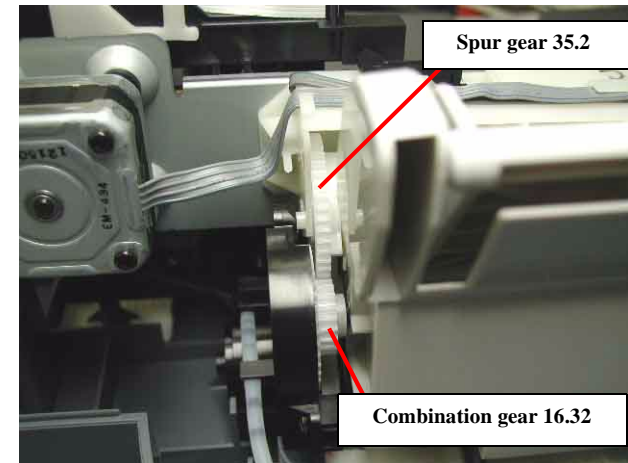

Figure 4-35. Spur Gear 35.2 and Combination gear 16.32

[Reference: Procedure for assembling the Holder shaft unit]

- 1) Set the tip of the Change lever in the Pump unit to the front side of the printer.

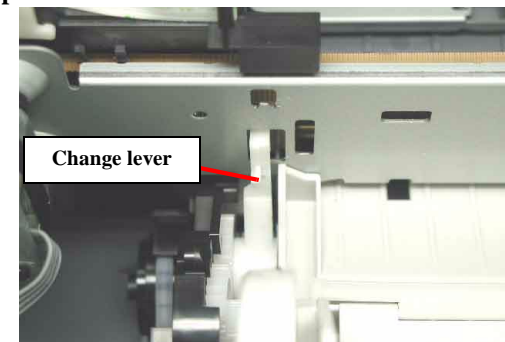

Figure 4-36. LD roller shaft holder assembling procedure (1)



- 2) Insert three hooks and one dowel of the Holder shaft unit in the order indicated in the following figure.

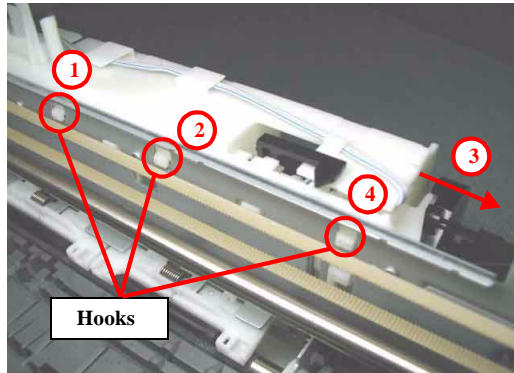

Figure 4-37. LD roller shaft holder assembling procedure (2)

When installing the dowel of the LD roller shaft holder to the Pump unit, move the Pump unit to the right side slightly.



- When removing or replacing the CR unit with new one, the following adjustment must be performed in the order below.
- 1) Top margin adjustment
 - 2) 1st dot position adjustment

4.2.8 Circuit board removal

1. Remove the Upper housing from the printer. (Refer to Section 4.2.1)
2. Remove the ASF unit from the printer. (Refer to Section 4.2.5)
3. Release two hooks for securing the SW button to the M/B mounting plate, and remove the SW button.

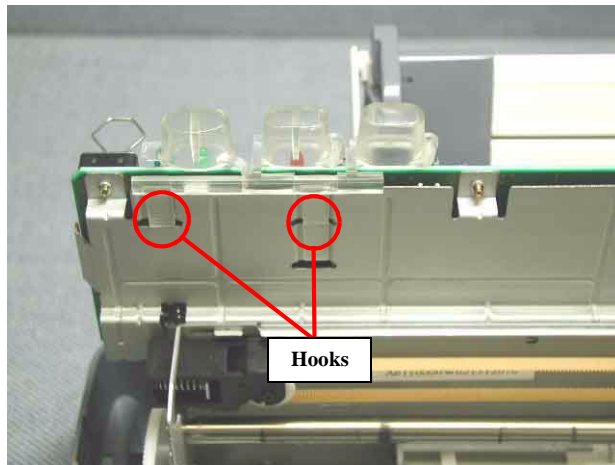

Figure 4-38. SW button removal

4. Disconnect the following six cables from the corresponding connectors on the Main board.
 - CR motor connector cable : CN12
 - PF motor connector cable : CN7
 - Head FFC : CN8, CN9
 - HP/PE sensor cable : CN4
 - Power supply connect cable : CN2

5. Remove four screws (C.B.S. SCREW 3x6 F/Zn, C.B.S. SCREW 3x14 F/Zn) for securing the Main board shield plate and Main board, and remove them.

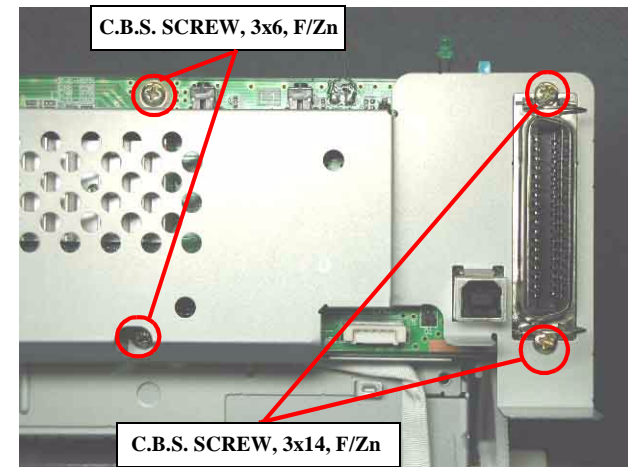

Figure 4-39. Circuit board removal

6. Slide the M/B mounting plate to the left side, and release the four hooks of the M/B mounting plate from the Main board.

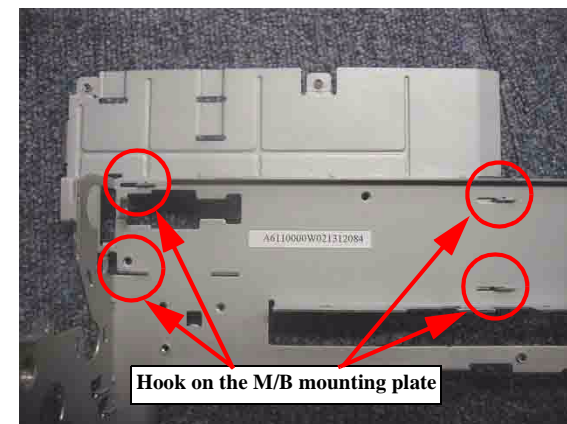

Figure 4-40. Hooks on the M/B mounting plate



- When removing the Main board shield plate from the Main board, pull the part indicated below vertically and remove it.

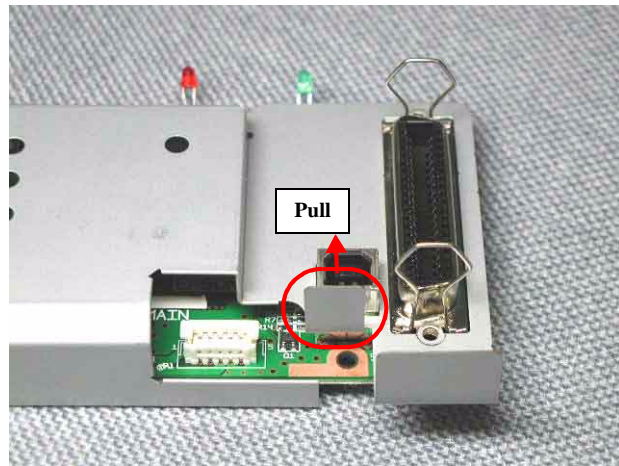

Figure 4-41. Main board shield plate removal



- When assembling the Main board to the M/B mounting plate,
 - Make sure to set it to the M/B mounting plate correctly.
 - Do not touch the LED on the Main board
- When assembling the Main board shield plate on the Main board,
 - When the M/B mounting plate is removed from the Printer mechanism, the hook of the M/B mounting plate deforms. Therefore, you have to use new one.
 - Make sure that the metal fittings for locking the Parallel interface is on its shield plate.

- Fasten four screws (C.B.S. SCREW 3x6 F/Zn, C.B.S. SCREW 3x14 F/Zn) for securing the Main board shield plate and the Main board to the Main frame in the order indicated in the following figure.

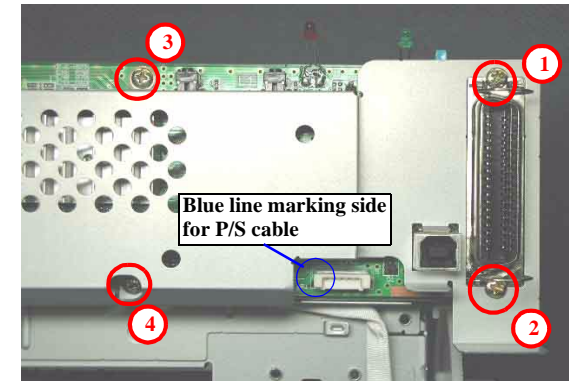

Figure 4-42. Circuit board assembling

Tightening torque for each screw is as follows.

- C.B.S. SCREW, 3x6, F/Zn (2 pcs) : 9 ± 1 kgf.cm
- C.B.S. SCREW, 3x14, F/Zn (2 pcs) : 9 ± 1 kgf.cm
- Make sure to connect all cables to the connectors (CN2, CN4, CN7, CN8, CN9, CN12) on the Main board in the correct direction. (Refer to Figure 4-42)
- When assembling the SW button,
 - Make sure that two hooks of the SW button is correctly fixed to the Main frame.



- When replacing the Main board with new one, perform the following service items.

- Before removing the Main board, connect the parallel I/F or USB cable and try to read out the following data by using the Adjustment program. If this operation succeeds, replace the Main board and write the read out data to new Main board by using the Adjustment program. (Refer to Chapter 5)
 - 1) Ink consumption counter (Address : 10H ~ 1FH)
 - 2) Waste drain ink pad counter (Address : 0AH ~ 0BH)
 - 3) Head ID (Address : 3FH ~ 4CH)
 - 4) Gap adjustment (Bi-d adjustment)
(Address : 2AH ~ 2BH, 33H ~ 38H)
 - 5) Top margin adjustment (Address : 2EH)
 - 6) 1st dot position adjustment (Address : 39H)
 - 7) USB ID (Address : 4DH ~ 5EH)
 - 8) Market ID (Address: 5FH)

In case that the above mentioned data are not able to be read out from the defective Main board, perform the following service items after replacing the Main board with new one.

- 1) Replace the both ink cartridges with brand new one for the Ink consumption counter.
- 2) Replace the Waste drain ink pad with new one for the Waste drain ink pad counter.
- 3) Input the Head ID
- 4) Adjust the Bi-D alignment
- 5) Adjust the Top margin
- 6) Adjust the 1st dot position
- 7) Input the serial number for USB ID
- 8) Input EEPROM initial setting value for the Market ID

4.2.9 Waste drain ink pad (under the ASF unit) removal

1. Remove the Upper housing from the printer. (Refer to Section 4.2.1.)
2. Remove the ASF unit from the printer (Refer to Section 4.2.5)

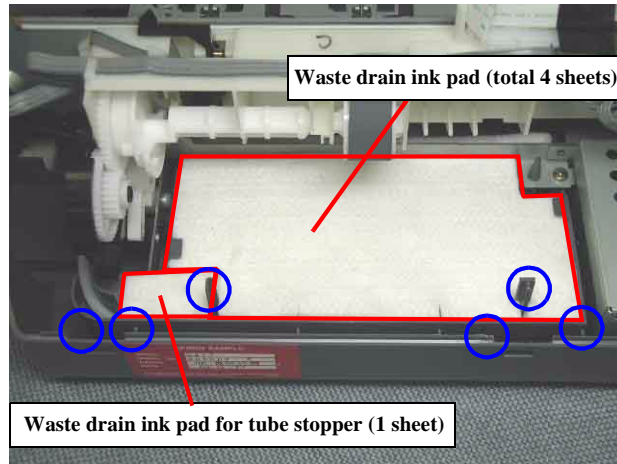

Figure 4-43. Waste drain ink pad setting position

3. Remove the Waste drain ink pad from the Lower housing.



- When disassembling/assembling the Waste drain ink pad, be careful not to hurt your hand with the protrusion of the Lower housing. (Refer to Figure 4-43: Blue circle)



- When assembling the Waste drain ink pad to the Lower housing,
 - Make sure to set the tip of the ink tube in the correct position of the Lower housing. Otherwise, it will cause ink leakage.

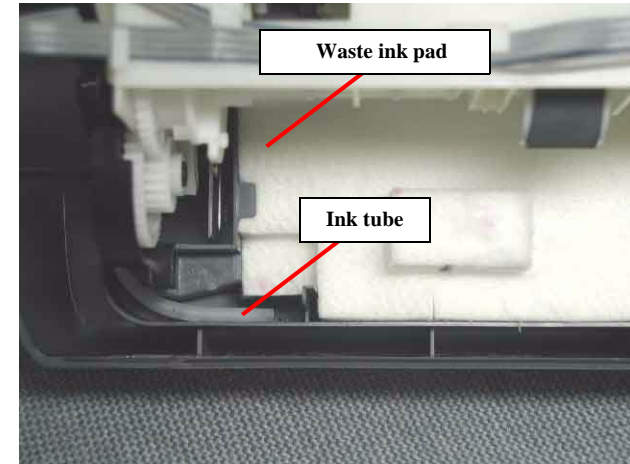

Figure 4-44. Ink tube setting position

- Avoid contacting the gears in the pump unit.
- Make sure to set the Waste drain ink pad in the correct position.



- When replacing the Main board with new one, perform the following service items.
 - 1) Waste drain ink counter reset (Protection counter A)

4.2.10 Lower housing removal

1. Remove the Upper housing from the printer. (Refer to Section 4.2.1)
2. Remove the CR unit from the printer. (Refer to Section 4.2.3)
3. Remove the ASF unit from the printer. (Refer to Section 4.2.5)
4. Remove the PSB/PSE unit from the printer. (Refer to Section 4.2.6)
5. Remove two screws (C.B.S. SCREW 3x6 F/Zn) for securing the Front frame to the Main frame.
6. Lift up the left side of the Front frame slightly, and slide the Front frame to the left side carefully with pulling the left side of the Front frame toward the front side of the printer.

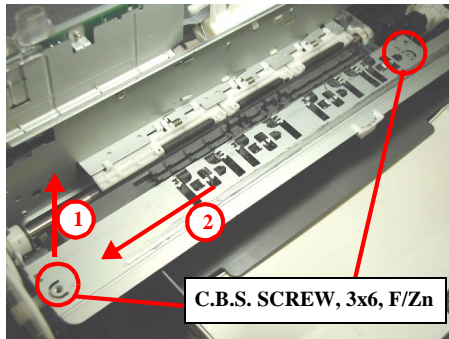

Figure 4-45. Front frame removal

CAUTION !

Do not damage the Spur gear 60 when sliding the Front frame to the left side.

CHECK POINT ✓

Return the CR unit to the CR home position before sliding the Front frame to the left side.

7. Slide the Paper eject roller to the left side while lifting up the following portion.

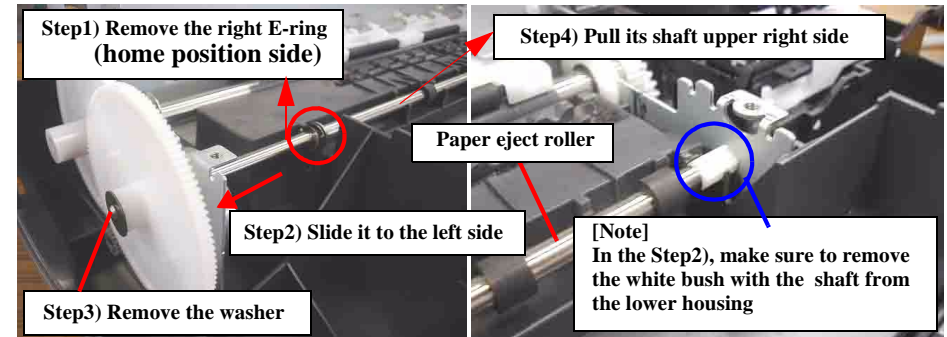

Figure 4-46. Paper eject roller sliding procedure

CAUTION !

Do not damage the Spur gear 60 when sliding the Paper eject roller to the left side.

CHECK POINT ✓

When removing the screw for securing the Printer mechanism on the left side of the printer, if the Paper eject roller is in the usual setting position, the screwdriver may damage the Spur gear 60.

- Remove three screws (C.B.P-TITE SCREW 3x8 F/Zn) for securing the Printer mechanism to the Lower housing.

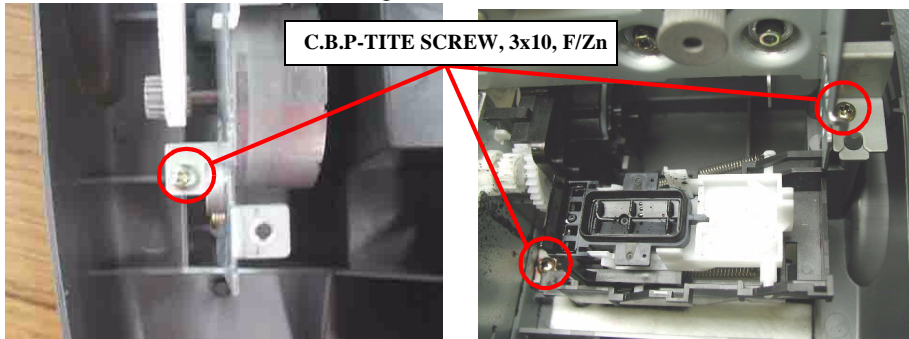

Figure 4-47. Printer mechanism removal (1)

- Release two hooks for securing the Cap unit to the Lower housing in the order indicated in the following figure.

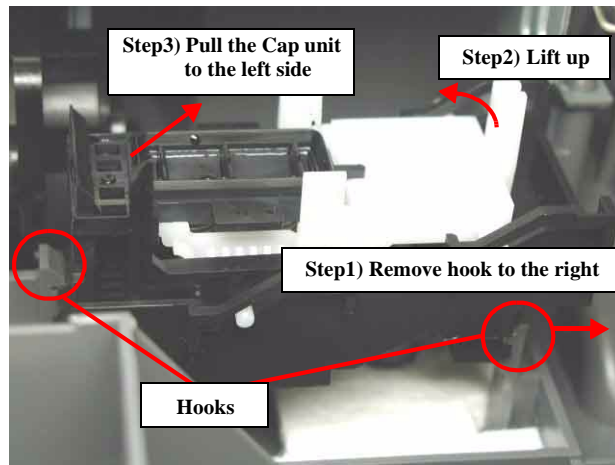

Figure 4-48. Cap unit removal

- Insert the protrusion of the Cap unit into the cutout portion of the Main frame as shown figure below.

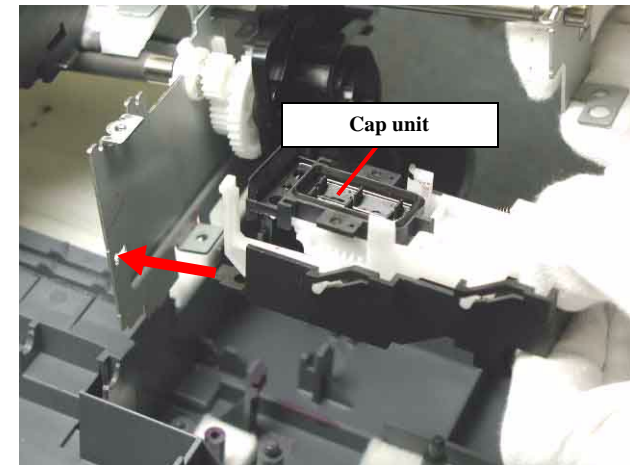

Figure 4-49. Cap unit setting position



- Do not touch the sealing rubber portion and the cleaner head of the Cap unit when inserting the Cap unit to the Main frame.

11. Lift the right side of the Printer mechanism carefully while releasing one hook for securing the Printer mechanism to the Lower housing from the backside of the Printer by using the tweezers.

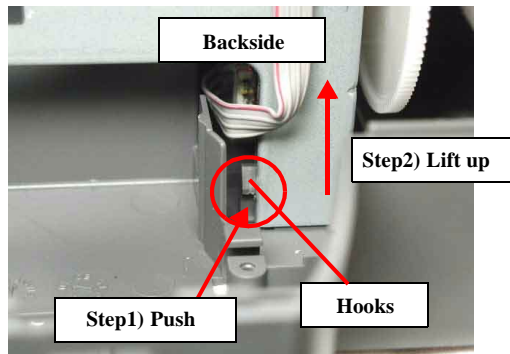

Figure 4-50. Printer mechanism removal (2)

12. Remove the Printer mechanism by lifting it at the points shown below (In this time, the Paper eject roller is also removed with the Printer mechanism).

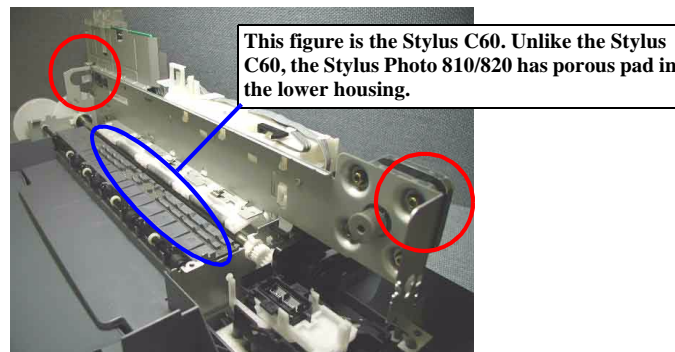

Figure 4-51. Printer mechanism removal



- When lifting the Printer mechanism from the Lower housing, be careful not to drip off the ink from the end (Waste drain ink pad side) of the ink tube.
- Do not remove the Printer mechanism upward by lifting it at the unspecified position to avoid the deformation of the Main frame.



- When assembling the Printer mechanism to the Lower housing,
 - Make sure to set the Main frame reinforcing plate correctly at the rightmost screw.

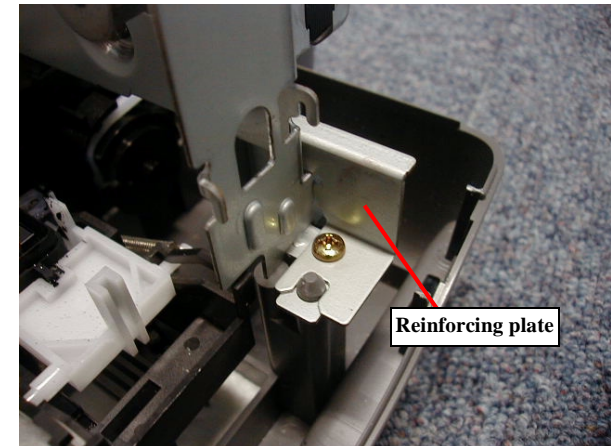

Figure 4-52. Reinforcing plate setting position

- Avoid to damage the coated surface of the PF roller by using the OHP sheet as shown figure below.

This figure is the Stylus C60. Unlike the Stylus C60, the Stylus Photo 810/820 has porous pad in the lower housing.

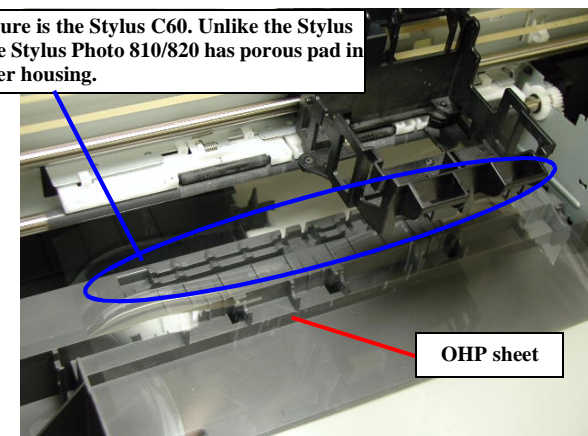

Figure 4-53. Printer mechanism assembling(1)



- Do not damage the tooth of the Spur gear 60 of the Paper eject roller because its roller is not fixed.
- Fasten three screws (C.B.S. SCREW 3 x10 F/Zn) for securing the Printer mechanism to the Lower housing.

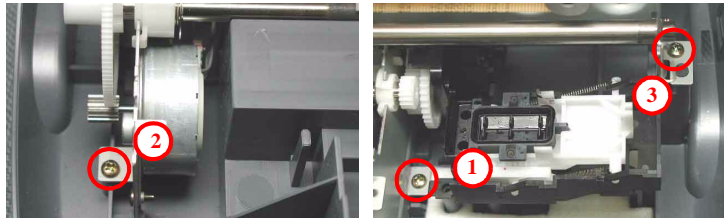

Figure 4-54. Printer mechanism assembling(2)

Tightening torque for each screw is as follows.

- C.B.S. SCREW, 3 x 10, F/Zn (3pcs) : 6 ± 1 kgf.cm

- Be careful not to drop the Cap unit from the Main frame.
- Do not touch the sealing rubber portion and the cleaner head of the Cap unit.
- Make sure that the Cap unit is correctly fixed to the Main frame.
- Make sure to set the end of ink tube correctly.
- Make sure to place the Ink tube as shown figure below.

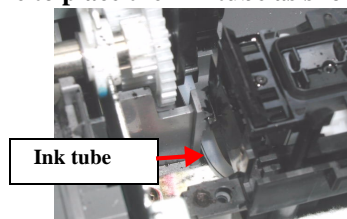

Figure 4-55. Ink tube setting position

- When assembling the Paper eject roller to the Lower housing by sliding its roller,
 - Do not damage the tooth of the Spur gear 60 with the PF motor pinion gear.

- Do not touch the rubber portion.
- Make sure that the Paper eject roller moves smoothly.
- Make sure to set the white bush in the correct direction.

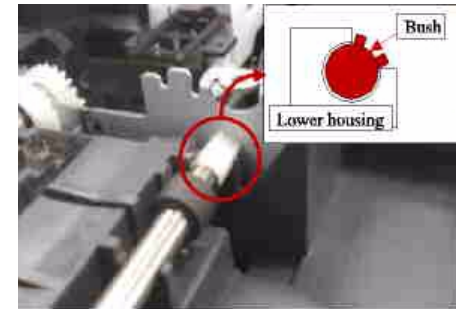

Figure 4-56. Bush position of the Paper eject roller

- When assembling the Front frame to the Main frame,
 - Make sure that the Star wheel moves smoothly.
 - Make sure that the Star wheel eject holder is correctly fixed.
 - Fasten two screws (C.B.S. SCREW 3x6 F/Zn) for securing the Front frame to the Main frame (Refer to Figure 4-45)

Tightening torque for each screw is as follow.

- C.B.S. SCREW, 3 x 6,F/Zn (2 pcs) : 9 ± 1 kgf.cm

- Make sure that the CR unit moves smoothly.



- When you replace the Front frame with new one, lubricate it with the suitable amount of the G-58 grease by the specified position. (Refer to Figure 6-6/Figure 6-7 in the Chapter 6)
- When you replace the Paper eject roller and the Spur gear 60 with new one, lubricate it with the suitable amount of G-58 grease by the specific position. (Refer to Figure 6-8 in the Chapter 6)

* However, you need not to perform the lubrication for the Paper eject roller and the Spur gear 60 unless the these parts are established for the service part.

4.2.11 Caution regarding Ink system removal, PF roller unit removal and PF motor removal

- In case that you remove or replace the Ink system (Cap unit & Pump unit), the PF roller unit and PF motor, we recommend to replace to new Printer mechanism with the Lower housing
This is because these parts have to be removed or replaced with the Printer mechanism condition without the Lower housing.
If you perform the operation with the condition, the Main frame is deform and the product quality may be lowered.
 - Adjustment after replacing the Printer mechanism
When removing or replacing the Printer mechanism with new one, the following adjustment must be performed in the order below.
 - 1) Drain ink counter reset
 - 2) Gap adjustment (Bi-d adjustment)
 - 3) Top margin adjustment
 - 4) 1st dot position adjustment
- However, in case that you perform the operation with Printer mechanism without the Lower housing in urgent case, the procedures from the next page should be followed surely.
- You cannot replace the Paper eject roller and the Spur gear 60 with new one because these parts are not established for service part.

4.2.12 Ink system unit removal (Cap unit, Pump unit & Waste drain ink pad)

1. Remove the Upper housing from the printer. (Refer to Section 4.2.1)
2. Remove the CR unit from the printer. (Refer to Section 4.2.3)
3. Remove the ASF unit from the printer. (Refer to Section 4.2.5)
4. Remove the PSB/PSE unit from the printer. (Refer to Section 4.2.6)
5. Remove the Holder shaft unit from the printer. (Refer to Section 4.2.7)
6. Remove the Lower housing from the printer mechanism. (Refer to Section 4.2.10)
7. Place the Cap unit in the following direction on the table.

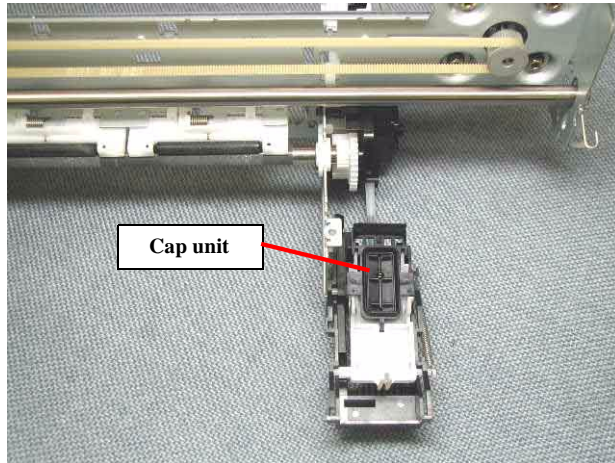

Figure 4-57. Cap unit removal

8. Put the right edge of the Main frame on an object so that the Printer mechanism becomes tilted (This is to prevent that gears in the Pump unit drops.).

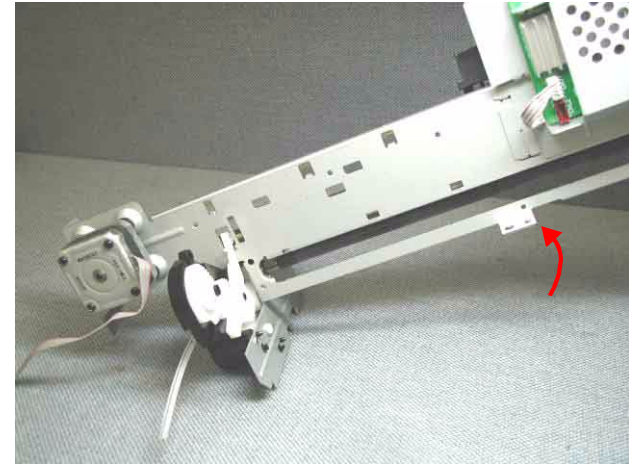

Figure 4-58. Ink system unit removal position

9. Release three hooks for securing the Pump unit to the Main frame in the order indicated in the following figure.

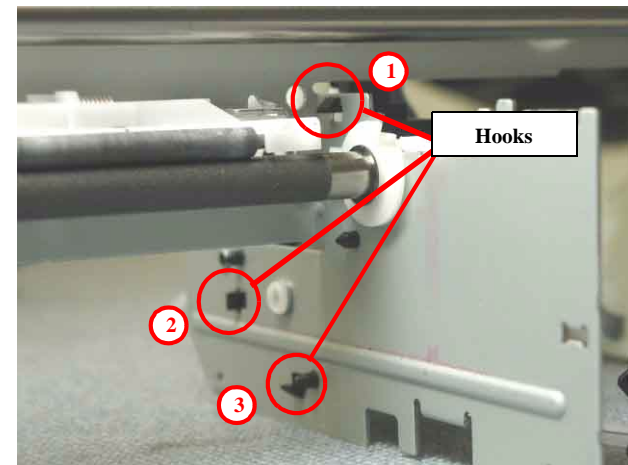

Figure 4-59. Ink system removal procedure

10. Remove the Ink system unit (Cap unit and Pump unit) carefully.



- When removing the Ink system unit, be careful so that the gears do not come off from each shaft of the Ink system frame.

11. Remove four gears (Combination gear 16.32, Spur gear 25.6 with the Change lever, Spur gear 27.2, Combination gear 18.28) and the Pump pulley, and get out of the ink tube from the Ink system frame.

12. Remove the Waste drain ink pad under the Cap unit from the Lower housing.



- When getting out of the ink tube, check the marking on the ink tube in advance.

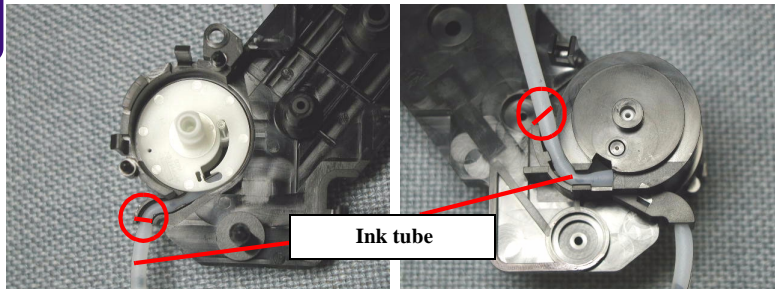

Figure 4-60. Marking position on the Ink tube



- When assembling as the Cap unit,
 - Do not touch the sealing rubber portion and the Cleaner head of the Cap unit.
 - Be careful not to crash or leave any stress on the Ink tube.
 - Make sure to set the marking position of the ink tube as shown figure below.

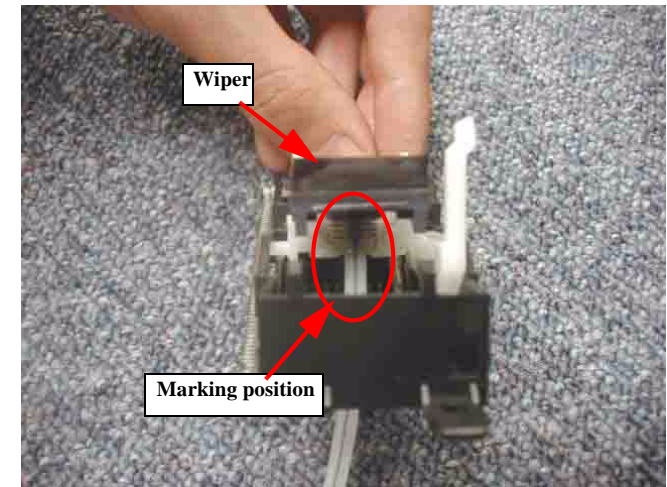

Figure 4-61. Pump tube setting position



- When assembling as the Pump unit,
 - Be careful not to crash or leave any stress on the Ink tube.
 - Make sure that all gears are correctly set in each gear shaft of the Ink system frame, and make sure that all gears can be rotated smoothly.

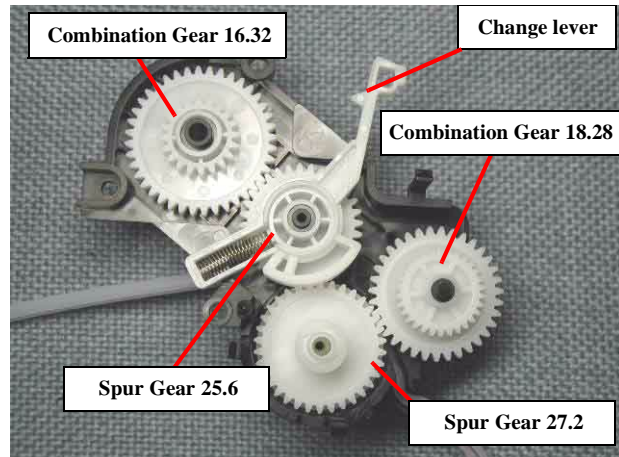

Figure 4-62. Gear engagement on the Ink system frame

- Make sure to set the marking position of the ink tube to the suitable position of the Pump frame. (Refer to Figure 4-60)

- Make sure to set the Compression spring 1.764 for the Change lever in the correct condition.

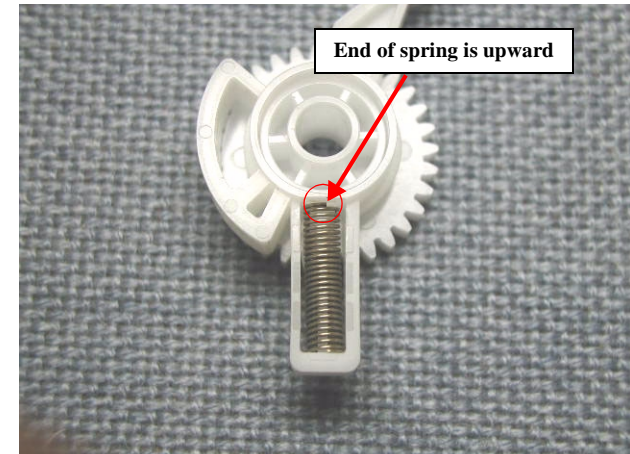

Figure 4-63. Compression spring 1.764 setting position

In this time, set the end of the Compression spring 1.764 upward.

4.2.13 PF roller unit removal

1. Remove the Upper housing from the printer. (Refer to Section 4.2.1)
2. Remove the CR unit from the printer (Refer to Section 4.2.3)
3. Remove the ASF unit from the printer. (Refer to Section 4.2.5)
4. Remove the PSB/PSE unit from the printer. (Refer to Section 4.2.6)
5. Push the dowels of the Paper guide by using the tweezers, and pull the Paper guide toward the front side of the printer.

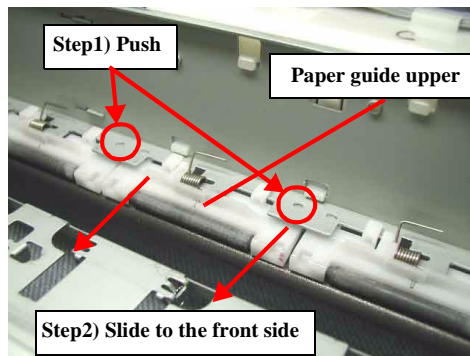

Figure 4-64. Paper guide removal procedure (1)



- When removing the Paper guide upper/left, avoid to damage the coated surface of the PF roller by using the OHP sheet as shown figure below.

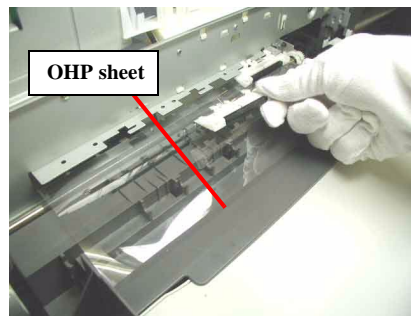

Figure 4-65. Paper guide removal procedure (2)

6. Remove the Lower housing from the printer mechanism. (Refer to Section 4.2.10)
7. Remove the Plain washer, 6.9 x 0.5 x 10.4, L/Na by using the tweezers, and slide the right PF roller bushing to the left side slightly.

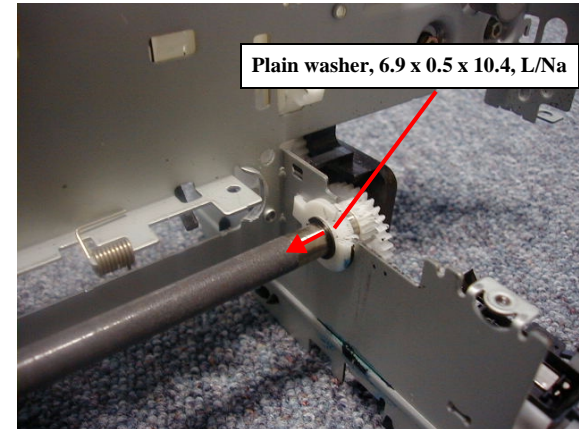

Figure 4-66. PF roller removal (1)

8. Remove the PF roller from the Main frame while sliding the left PF roller bushing to the right side by using the tweezers.

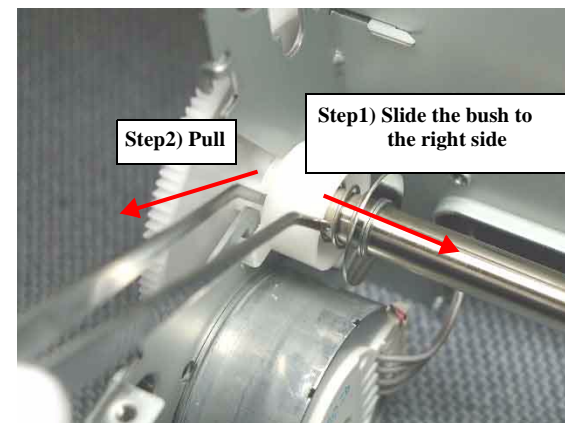

Figure 4-67. PF roller removal (2)



- When removing the PF roller, be careful not to damage the Spur gear 60 with the Main frame.



- When assembling the PF roller unit to the Main frame,
 - Be careful not to damage the Spur gear 60 with the Main frame.
 - Make sure to set the PF roller bushing to the cutout portion of the Main frame.
- When assembling the Paper guide upper/left to the Main frame,
 - Avoid to damage the coated surface of the PF roller by using the OHP sheet. (Refer to Figure 4-65)
 - Make sure that the Paper guide is correctly fixed to the Main frame.

[Reference: Procedure for assembling the Paper guide]

1. Set the Torsion spring 48.51 into the groove of the Paper guide upper/left as shown figure below.

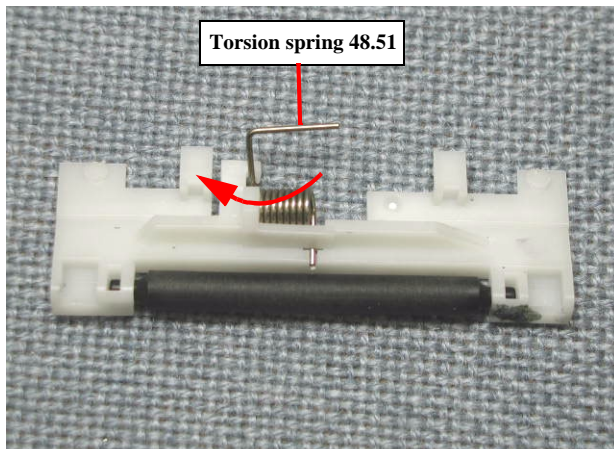

Figure 4-68. Paper guide assembling (1)



2. Install the Paper guide upper/left to the Main frame as shown figure below, and slide it to the right side.

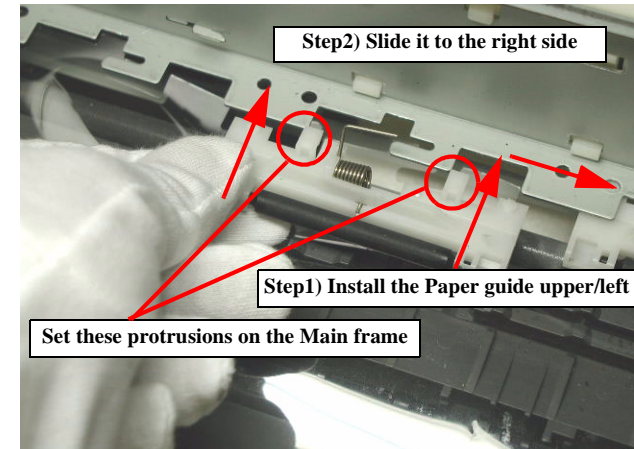

Figure 4-69. Paper guide assembling (2)

3. Release the Torsion spring 48.51 by using the tweezers as shown figure below.

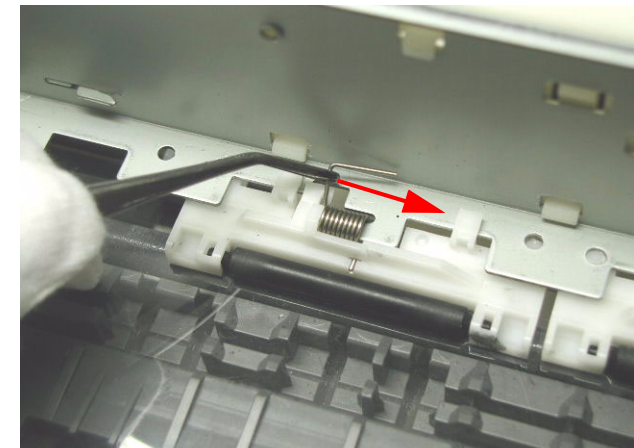

Figure 4-70. Paper guide assembling (3)

4.2.14 PF motor removal

1. Remove the Upper housing from the printer. (Refer to Section 4.2.1)
2. Remove the CR unit from printer. (Refer to Section 4.2.3)
3. Remove the ASF unit from the printer. (Refer to Section 4.2.5)
4. Remove the PSB/PSE unit from printer. (Refer to Section 4.2.6)
5. Remove the Circuit board from the printer. (Refer to Section 4.2.8)
6. Remove the PF roller unit from the printer. (Refer to Section 4.2.13)
7. Remove one screw (C.B.S. SCREW 3x6 F/Zn) for securing the PF motor to the Main frame, and remove the PF motor.

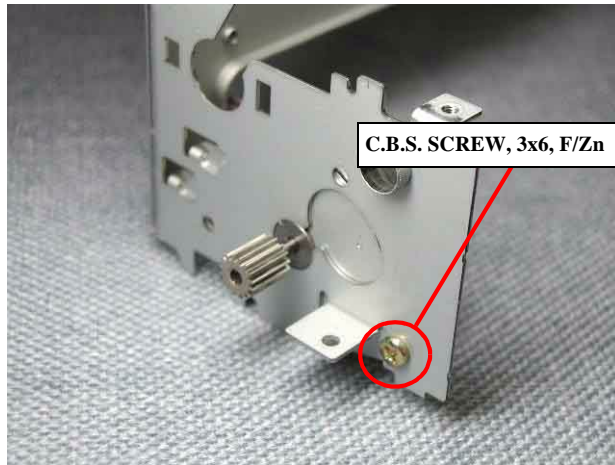

Figure 4-71. PF motor removal



- When assembling the PF motor to the Main frame,
 - Do not damage the PF motor pinion gear.
 - Make sure to place the PF motor connector cable to the Main frame properly before assembling the Main board.
 - Make sure to connect the PF motor connector cable to the connector (CN7) on the Main board by using the tweezers.
 - Fasten one screw (C.B.S. SCREW 3x6 F/Zn) for securing the PF motor to the Main frame (Refer to Figure 4-71).

Tightening torque for the screw is as follows.

- C.B.S. SCREW, 3x6, F/Zn (1 pcs) : 8 ± 1 kgf.cm



- When removing the PF motor, do not damage the pinion gear of the PF motor with the Main frame.

CHAPTER

5

ADJUSTMENT

5.1 Overview

This section describes the procedure for adjustments required when the printer is disassembled and assembled for repair or service.

5.1.1 Required Adjustment

If you remove or replace the specific part in your service/repair, you have to perform the appropriate adjustment as listed Table 5-1 below.

In this printer, it is necessary to perform appropriate adjustment in order to maintain consistent printing function and quality, eliminate differences of each printer mechanism's characteristics. Therefore, in case that the combination between the printer mechanism and the main board changes or the Printhead is replaced during the repair service, you must input the correct adjustment value into the EEPROM on the Main board by using the Adjustment program.



In case that any parts are removed and assembled on the repair product while running the Adjustment program, make sure to turn off the printer.

Table 5-1. Required Adjustment

Performance Priority	1	2	3	4	5	6	7	8
Adjustment item	EEPROM initial setting	Ink pad replacement or ink Counter reset	Initial ink charge	Head ID input	Bi-D adjustment	USB ID input	Top margin adjustment	1st dot adjustment
Replaced part								
Main board replacement	①	②	NA	③	④	⑤	⑥	⑦
Printhead removal	NA	NA	NA	NA	①	NA	②	③
Printhead replacement	NA	NA	①	②	③	NA	④	⑤
CR motor replacement	NA	NA	NA	NA	①	NA	NA	②
CR unit removal/replacement	NA	NA	NA	NA	①	NA	②	③
Printer mechanism replacement	NA	①	②	③	④	NA	⑤	⑥
Waste drain ink pad replacement	NA	①	NA	NA	NA	NA	NA	NA
ASF unit removal/replacement	NA	NA	NA	NA	NA	NA	①	②
Holder shaft unit removal/replacement	NA	NA	NA	NA	NA	NA	①	②

NOTE: “○”: Required necessary adjustment
 “□”: Required Adjustment for confirmation
 The numbers in the circle/square shows the required adjustment order.
 “NA”: Not applicable.
 • Following adjustments are not required on this product.
 -Platen Gap adjustment
 -Head Angular adjustment.

NOTE: • When the Main board is replaced with new one, you may have to replace the following parts also in case the EEPROM parameter back up function is not available on the defective main board.
 * Waste drain ink pad
 * Both Black & Color Ink Cartridge
 • After completing the adjustment, check the printing result with A4 check pattern by using the Adjustment program.
 If the result is not good, perform appropriate adjustment.

CHAPTER

6

MAINTENANCE

6.1 Overview

This section provides information to maintain the printer in its optimum condition.

6.1.1 Cleaning

This printer has no mechanical components which require regular cleaning except the Printhead. Therefore, when returning the printer to the user, check the following parts and perform appropriate cleaning if stain is noticeable.



- **Never use chemical solvents, such as thinner, benzene, and acetone to clean the exterior parts of the printer like the Housing. These chemicals may deform or deteriorate the components of the printer.**
- **Be careful not to damage any components when you clean inside the printer.**
- **Do not scratch the coated surface of the PF roller. Use soft brush to wipe off any dusts. Use a soft cloth moistened with alcohol to remove the ink stain.**
- **Do not use cleaning sheet included in the media for normal usage. It may damage the coated surface of PF roller. If the adhesive surface of the cleaning sheet is set to the LD roller shaft side and used to clean the LD roller surface, it is no problem.**

- Exterior parts
Use a clean soft cloth moistened with water, and wipe off any dirt. If the exterior parts are stained by the ink, use a cloth moistened with neutral detergent to wipe it off.
- Inside the printer
Use a vacuum cleaner to remove any paper dust.
- LD Roller
When paper loading function does not operate because friction of the LD roller is lowered by any paper dust, set the adhesive side up of the cleaning sheet (included in the media) to remove any paper dust. Repeat loading the cleaning sheet several times.

6.1.2 Service Maintenance

If any abnormal print (dot missing, white line, etc.) has occurred or the printer indicates the "Maintenance request error" (This error is displayed as "Maintenance call error" in the STM3), take the following actions to clear the error.

- Printhead cleaning
When dot missing or banding phenomenon has occurred, you need to perform the printhead cleaning operation*¹ by using the printhead cleaning function. This function can be performed by the control panel operation, the printer driver utility and the Adjustment program.
In case that the cleaning sequence is performed by the control panel operation, confirm that the printer is in stand-by state (the Power LED is lighting), and hold down the Error reset button on the control panel for more than 3 seconds. Then, the printer starts the cleaning sequence (the Power LED blinks during this sequence).
In case that you select and perform the manual cleaning by the printer driver utility, the most appropriate cleaning mode is selected. The following is the process to perform the printhead cleaning from the printer driver utility.
As for the operation of the Adjustment program, refer to Chapter 5 Adjustment.

*1: The Stylus PHOTO 810/820 has four modes for manual cleaning, and even during printing, the appropriate cleaning mode is automatically selected and performed according to various conditions. Therefore the ink consumption amount for manual cleaning varies depending on each mode (Refer to Chapter 2).

1. Select the “EPSON Status Monitor 3” in the printer driver utility, and make sure that the printer is in stand-by state by using the Status monitor 3. If the printer is in stand-by state, the following figure is indicated on the monitor.

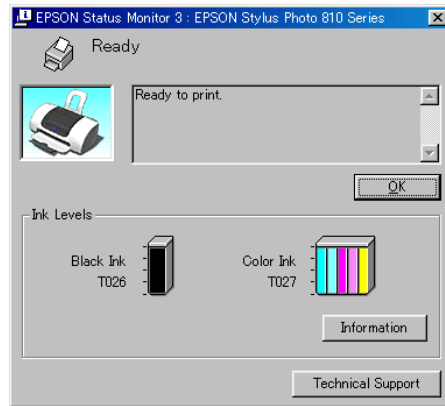

Figure 6-1. Status monitor 3 indication

2. Select the “Head Cleaning” in the printer driver utility, and perform the printhead cleaning. After performing the printhead cleaning operation, print a nozzle check pattern by selecting the “Nozzle Check”. If you repeat the printhead cleaning operation without selecting the “Nozzle Check”, CL1, the weakest cleaning, will be repeated.

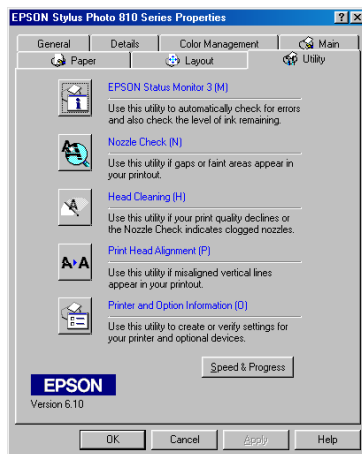

Figure 6-2. Head cleaning function in the printer driver utility

- Maintenance request error (Maintenance call error)
Ink is used for the printhead cleaning operation as well as the printing operation. When the ink is used for the printhead cleaning operation, the ink is drained to the Waste drain ink pad and the amount of the waste ink is stored as the waste ink counter into the EEPROM on the Main board. Due to this, when the waste ink counter has reached the limit (Waste ink counter = Protection counter A = 32915 points) of the absorbing capability of the Waste drain ink pad, the Maintenance call error is indicated on Status monitor 3 as following figure.

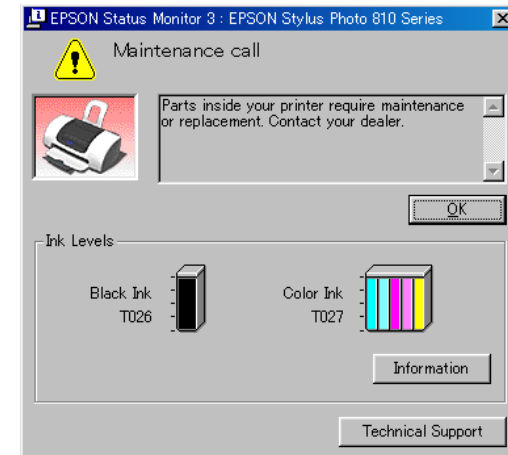

Figure 6-3. Maintenance error indication in STM3

In this case, replace to new Waste drain ink pad and clear the waste ink counter stored into the EEPROM. The waste ink counter can be reset only from the Adjustment program because this printer dose not have the waste ink counter reset function by the control panel SW. As for the procedure, refer to Chapter 5 Adjustment.

In your repair activity, check the waste ink counter along with the firmware version, Main board checker program version and nozzle check pattern on the nozzle check pattern printing. If the waste ink counter is closed to its limit, recommend that the Waste drain ink pad will be replaced with new one. This is because the "Maintenance request error" will may occur after returning the repaired product to the customer.

6.1.3 Lubrication

The characteristics of the grease have great affects on the mechanical function and durability, especially does the characteristics about temperature environment. The type and amount of the grease used to lubricate the printer parts are determined based on the results of the internal evaluations. Therefore, be sure to apply the specified type and amount of the grease to the specified part of the printer mechanism during servicing.



- Never use oil or grease other than those specified in this manual. Use of different types of oil or grease may damage the component or give bad influence on the printer function.
- Never apply larger amount of grease than specified in this manual.

Table 6-1. Specified lubricants

Type	Name	EPSON code	Supplier
Grease	G-58	1082176	EPSON

Table 6-2. Lubrication point

No.	Lubrication type/point	Remarks
1	<p><Lubrication point></p> <ul style="list-style-type: none"> • Along the circle of the CR guide shaft (4 points) Refer to Figure 6-4. <p><Lubrication type></p> <ul style="list-style-type: none"> • G-58 <p><Lubrication amount></p> <ul style="list-style-type: none"> • Total = 100 mg (25 mg for each point) 	<ul style="list-style-type: none"> • Do not attach the grease to other portion of the CR unit. • Use a syringe to apply it. • Move the CR unit from side to side in order to spread it evenly. • After lubrication, make sure that the CR unit moves smoothly.
2	<p><Lubrication point></p> <ul style="list-style-type: none"> • Groove of the Pulley driven holder. (4 points) Refer to Figure 6-5. <p><Lubrication type></p> <ul style="list-style-type: none"> • G-58 <p><Lubrication amount></p> <ul style="list-style-type: none"> • Φ1mm x 1mm for each point 	<ul style="list-style-type: none"> • Use a syringe to apply it.

Table 6-2. Lubrication point

No.	Lubrication type/point	Remarks
3	<p><Lubrication point></p> <ul style="list-style-type: none"> • Middle/Cutout portion of the Front frame. Refer to Figure 6-6/Figure 6-7. <p><Lubrication type></p> <ul style="list-style-type: none"> • G-58 <p><Lubrication amount></p> <ul style="list-style-type: none"> • Middle : Φ1mm x 300mm • Cutout portion : Φ1mm x 20mm 	<ul style="list-style-type: none"> • Use a syringe to apply it. • After lubrication, move the CR unit from side to side in order to spread it evenly.
4	<p><Lubrication point></p> <ul style="list-style-type: none"> • Upward teeth area of the Spur gear 60. Then, rotate it 90 degrees to the backside of the printer. Refer to Figure 6-8. <p><Lubrication type></p> <ul style="list-style-type: none"> • G-58 <p><Lubrication amount></p> <ul style="list-style-type: none"> • Φ1mm x 20mm 	<ul style="list-style-type: none"> • Use a syringe to apply it. • Do not touch the lubrication area. <p>[Note] You need not to perform this lubrication unless the this part is established for the service part.</p>
5	<p><Lubrication point></p> <ul style="list-style-type: none"> • Center of the Pulley driven shaft (1 point) • Around the hole of the Pulley driven (2 points) Refer to Figure 6-9. <p><Lubrication type></p> <ul style="list-style-type: none"> • G-58 <p><Lubrication amount></p> <ul style="list-style-type: none"> • Pulley driven shaft : Φ1 mm x 1mm • Pulley driven : Φ1 mm x 1mm for each position 	<ul style="list-style-type: none"> • Use a syringe to apply it.

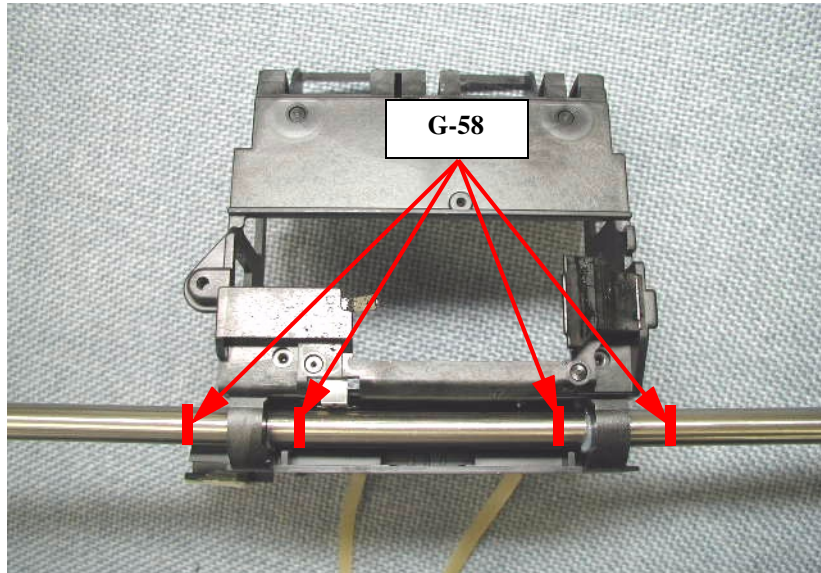

Figure 6-4. Lubrication point 1

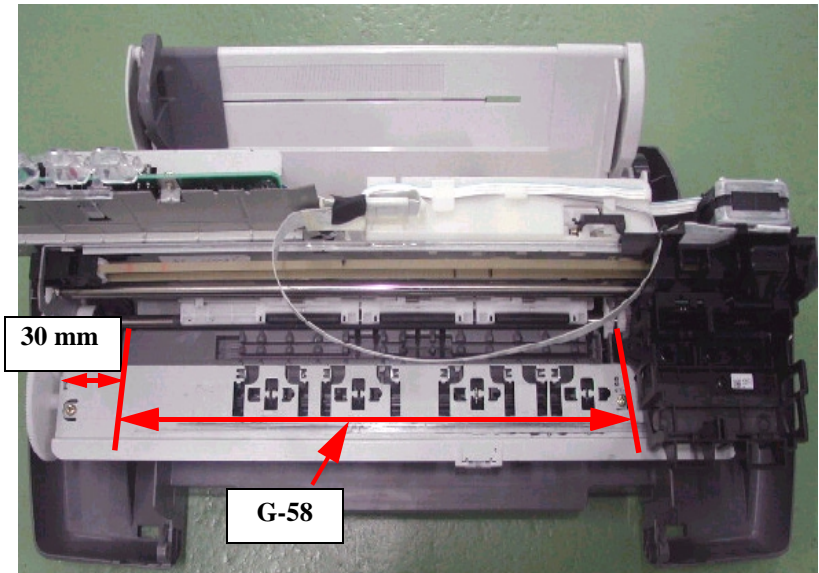

Figure 6-6. Lubrication point 3 (1)

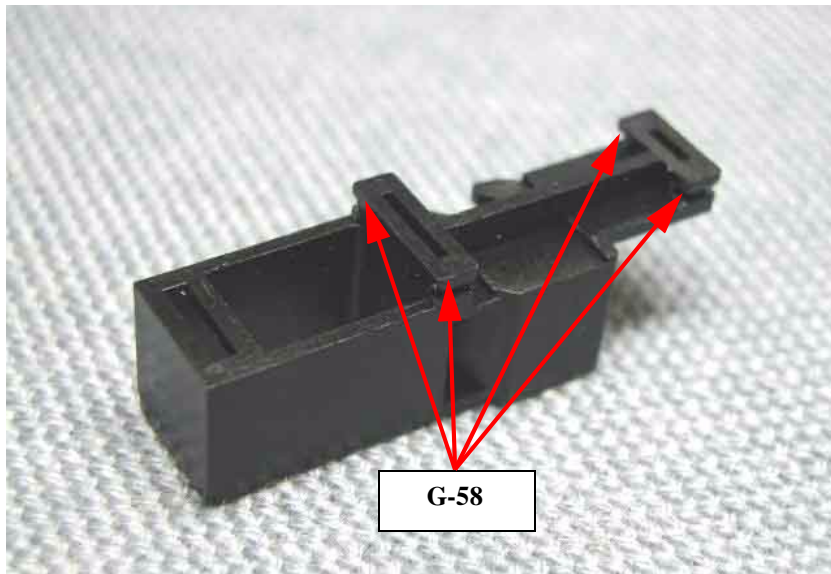

Figure 6-5. Lubrication point 2

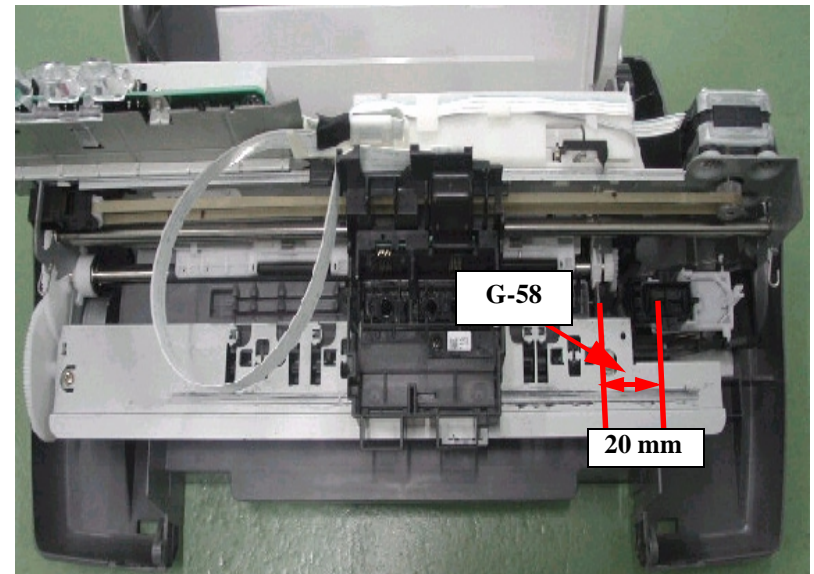

Figure 6-7. Lubrication point 3 (2)

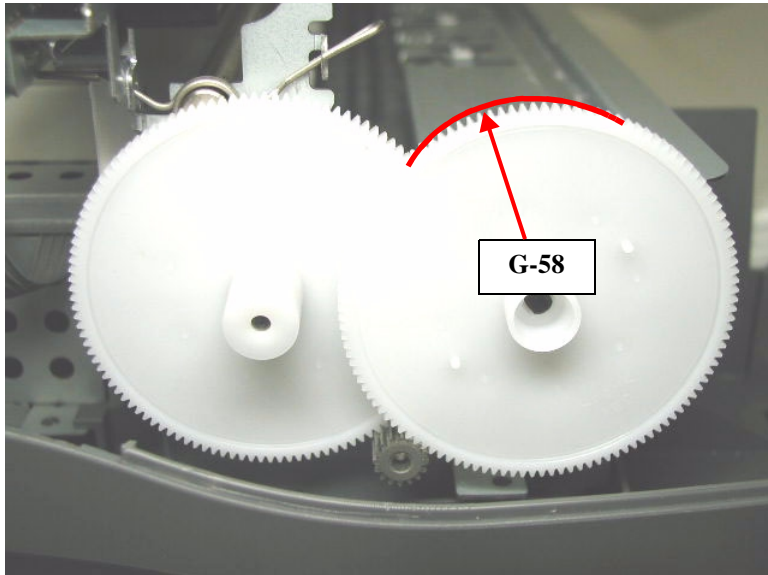

Figure 6-8. Lubrication point 5

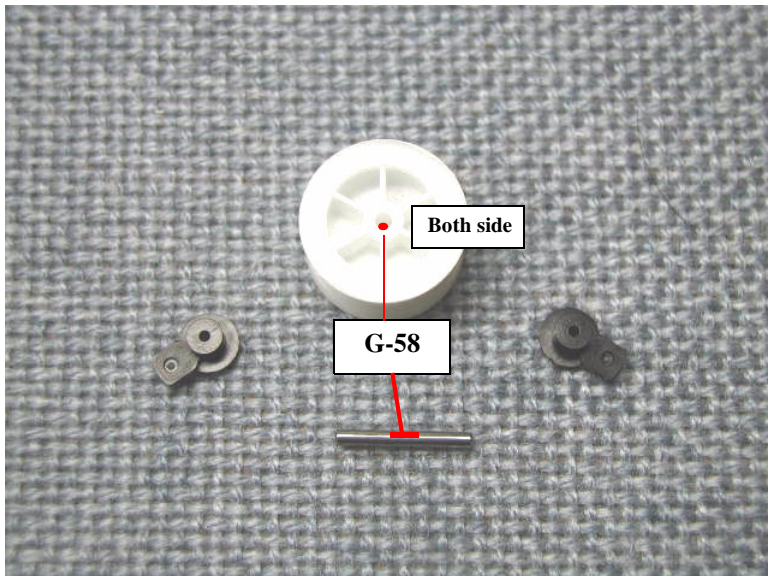

Figure 6-9. Lubrication point 6

CHAPTER

7

APPENDIX

7.1 Connector Summary

7.1.1 Major Component Unit

The major component units of this printer are as follows.

- C418 Main/Main-B Board
- Power Supply Board (C417PSB/PSE)

The figure below shows how to connect these components.

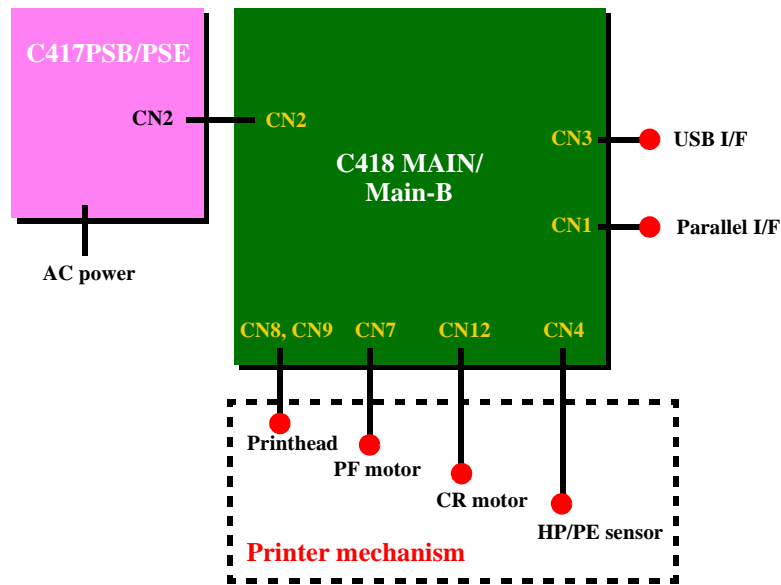

Figure 7-1. Connection of the major components

See the following tables for the connector summary for the C417 Main/C418 Main board and each connector's pin alignment.

Table 7-1. Connector Summary for C417 MAIN

Connector	Function	Table to refer to
CN1	For connection with the Parallel interface	Refer to 1.3.1 "Parallel Interface (Forward Channel)"
CN2	For connection with the Power supply board	Table 7-2
CN3	For connection with the USB	Refer to 1.3.3 "USB Interface"
CN4	For connection with the HP/PE sensor	Table 7-3
CN7	For connection with the PF motor	Table 7-4
CN8, CN9	For connection with the printhead	Table 7-5, Table 7-6
CN12	For connection with the CR motor	Table 7-7

Table 7-2. CN2 - Power Supply Board

Pin	Signal Name	I/O	Function
1	PSC	---	PSC signal
2	GND	---	Ground
3	+42V	---	Mechanism drive power supply
4	GND	---	Ground
5	+5V	---	Logic power supply

Table 7-3. CN4 - HP/PE Sensor

Pin	Signal Name	I/O	Function
1	HPPE	In	Sensor detect signal
2	GND	---	Ground
3	HPPEV	---	Sensor Power Supply

Table 7-4. CN7 - PF Motor

Pin	Signal Name	I/O	Function
1	PFA	Out	Phase drive signal (A)
2	PFB	Out	Phase drive signal (-A)
3	PF-A	Out	Phase drive signal (B)
4	PF-B	Out	Phase drive signal (-B)

Table 7-5. CN8 - Printhead

Pin	Signal Name	I/O	Function
1	GND	---	Ground
2	COM	---	Head drive pulse (trapezoid waveform)
3	GND	---	Ground
4	VHV	---	-42 V power supply for nozzle selector
5	GND	---	Ground
6	NCHG	Out	All nozzle fire selection pulse
7	GND	---	Ground
8	LAT	Out	Head data latch pulse output
9	VDD3.3	---	Logic power supply (+3.3V)
10	CCLK	Out	Clock signal for EEPROM
11	COI	In	I/C detection signal
12	CRST	Out	Reset signal for EEPROM
13	THM	In	Thermistor detection signal
14	CSDA	In/Out	CSIC data signal for EEPROM
15	CVDD	---	Logic power supply (+3.3V) for EEPROM

Table 7-6. CN9 - Printhead

Pin	Signal Name	I/O	Function
1	SP	Out	Select signal for CH signal
2	SI1	Out	Print data output (1)
3	SI2	Out	Print data output (2)
4	SI3	Out	Print data output (3)
5	SI4	Out	Print data output (4)
6	SI5	Out	Print data output (5)
7	SI6	Out	Print data output (6)
8	GND	---	Ground
9	CH	Out	Waveform selection signal for MS shot & Variable shot
10	GND	---	Ground
11	SCK	Out	Serial Clock
12	GND	---	Ground
13	COM	---	Head drive pulse (trapezoid waveform)
14	GND	---	Ground
15	COM	---	Head drive pulse (trapezoid waveform)

Table 7-7. CN12 - CR Motor

Pin	Signal Name	I/O	Function
1	CRA	Out	Phase drive signal (A)
2	CRB	Out	Phase drive signal (-A)
3	CR-A	Out	Phase drive signal (B)
4	CR-B	Out	Phase drive signal (-B)

7.1.2 EEPROM Address Map

Table 7-8. EEPROM Address Map

Address	Explanation	Setting	QPIT settings	Factory settings
00H	Ink flag1	Bit7: CSIC Disable Bit6: black one-time Bit5: color one-time Bit4: Initial charge required Bit3: Reserved Bit2: ink cleaning seq. Bit1: black CL required Bit0: color CL required	00H	10H
01H	Ink flag2	Bit7: Printed after Cleaning 0:Not printed after Cleaning 1:Printed after Cleaning Bit6: Black 1st Ink Cartridge Bit5: Color 1st Ink Cartridge Bit4: Bk CSIC changed Flag1 Bit3: YMC CSIC changed Flag1 Bit2: YMC cartridge change and cleaned 0:first cartridge 1:changed Bit0: Black cartridge change and cleaned 0:first cartridge 1:changed Bit0: Black cartridge change and cleaned 0:with YMC cartridge 1:alone	00H	00H
02H	CL time		00H	00H
03H			00H	00H
04H	CPU Time		00H	00H
05H			00H	00H

Table 7-8. EEPROM Address Map (continued)

Address	Explanation	Setting	QPIT settings	Factory settings
06H	Accumulated printing time		00H	00H
07H			00H	00H
08H	Initial Charge Counter		00H	00H
09H	D4 mode I/F	Bit7: I/F Control Flag Bit6:	04H	04H ^{*a}
		Bit5: Reserved Bit4:		
		Bit3: D4 mode USB Bit2:		
		Bit1: D4 mode Parallel Bit0:		
0AH	Ink counter A0		00H	00H
0BH			00H	00H
0CH	Ink counter Rb0		00H	00H
0DH			00H	00H
0EH	Ink counter Ry0		00H	00H
0FH			00H	00H
10H	Ink counter Cb		00H	00H
13H			00H	00H
14H	Ink counter Cy		00H	00H
17H			00H	00H
18H	Ink counter Cm		00H	00H
1BH			00H	00H

Table 7-8. EEPROM Address Map (continued)

Address	Explanation	Setting	QPIT settings	Factory settings
1CH 1FH	Ink counter Cc		00H 00H	00H 00H
20H 23H	Ink counter Clm		00H 00H	00H 00H
24H 27H	Ink counter Clc		00H 00H	00H 00H
28H	ERROR Code		00H	00H
29H	Reserved		00H	00H
2AH	Bi-D Adjustment for Normal dot Bk	-36<=n<=+36 (by 1/2880inch)	00H	(*1)
2BH	Bi-D Adjustment for Normal dot Cr	-36<=n<=+36 (by 1/2880inch)	00H	(*1)
2CH	Reserved		00H	00H
2DH	Manufacturer setting	Bit7,6: Name mode Bit5-0: Customer name	00H	(*1) *b
2EH	Offset of Loading Step		00H	(*1)
2FH	Reserved		00H	00H

data in 00h ~ 2Fh are written to EEPROM at NMI

*a : D4 mode setting (EEPROM 09H)

USB

Bit3	Bit2	D4 mode
0	0	Auto
0	1	On
1	0	Off

Parallel

Bit1	Bit0	D4 mode
0	0	Auto
0	1	On
1	0	Off

*b : Manufacture and Description name show the following setting.

Name mode

Bit7	Bit6	Name mode
0	0	Ineffective
0	1	Apply to the Description and Manufacturer.
1	0	Apply to the Description.
1	1	Reserved

Customer name

Bit5	Bit4	Bit3	Bit2	Bit1	Bit0	Customer name
0	0	0	0	0	0	Acer
0	0	0	0	0	1	Apple
0	0	0	0	1	0	Compaq
0	0	0	0	1	1	Dell
0	0	0	1	0	0	Machines
0	0	0	1	0	1	Fujitsu
0	0	0	1	1	0	Hewlett-Packard
0	0	0	1	1	1	IBM
0	0	1	0	0	0	Gateway
0	0	1	0	0	1	NEC
0	0	1	0	1	0	Panasonic
0	0	1	0	1	1	Sharp
0	0	1	1	0	0	Sony
0	0	1	1	0	1	Toshiba
0	0	1	1	1	0	PHILIPS

Table 7-9. EEPROM Address Map (continued)

Address	Explanation	Setting	QPIT setting	Factory setting
30H	Interface selection	01H : Auto 02H : Parallel 08H : USB Others : Auto	00H	00H
31H	Interface time-out	0 to 255 (by second, value of 0 means 10 seconds)	0AH	0AH
32H	I/F Speed	Bit7,6: Reserved Bit5: Reserved Bit4: Bit3: ECP speed Bit2: Bit1: Compatibility speed Bit0:	00H	00H
33H	Bi-D Adjustment 1 for Multi Shot Bk	-36<=n<=+36 (by 1/2880inch)	00H	(*1)
34H	Bi-D Adjustment 2 for 6plVSD Bk	-36<=n<=+36 (by 1/2880inch)	00H	(*1)
35H	Bi-D Adjustment 3 for 4plVSD Bk	-36<=n<=+36 (by 1/2880inch)	00H	(*1)
36H	Bi-D Adjustment for Multi Shot (Cl)	-36<=n<=+36 (by 1/2880inch)	00H	(*1)
37H	Bi-D Adjustment for 6plVSD (Cl)	-36<=n<=+36 (by 1/2880inch)	00H	(*1)
38H	Bi-D Adjustment for 4plVSD (Cl)	-36<=n<=+36 (by 1/2880inch)	00H	(*1)
39H	1st dot Position Adjustment	-36<=n<=+36 (by 1/2880inch)	00H	(*1)
3AH	CL2 Counter KK		00H	03H

Address	Explanation	Setting	QPIT setting	Factory setting
3BH	Total Timer CL Counter		00H	00H
3CH	Printer For CSIC		00H	9EH: World 19H: Japan
3DH 3EH	CSIC1_InkName1; CSIC2_InkName1;		00H	00H
3FH	Head Actuator Rank ID for VhN	+1<=n<=+32	00H	(*1)
40H	Head Actuator Rank ID for VhM	+1<=n<=+37	00H	(*1)
41H	Head Actuator Rank ID for VhL	+1<=n<=+34	00H	(*1)
42H	Head Actuator Rank ID for VhV	+1<=n<=+34	00H	(*1)
43H	Head Actuator Rank ID for VhU	+1<=n<=+40	00H	(*1)
44H	Head Actuator Rank ID for VhM2	+1<=n<=+34	00H	(*1)
45H	Head Actuator Rank ID for VhB	+1<=n<=+34	00H	(*1)
46H	Head Actuator Rank ID for AR	0<=n<=+6	00H	(*1)
47H	Head Actuator Rank ID for IwB	+30<=n<=+70	00H	(*1)
48H	Head Actuator Rank ID for IwC	+30<=n<=+70	00H	(*1)
49H	Head Actuator Rank ID for IwM	+30<=n<=+70	00H	(*1)

Address	Explanation	Setting	QPIT setting	Factory setting
4AH	Head Actuator Rank ID for IwY	+30<=n<=+70	00H	(*1)
4BH	Head Actuator Rank ID for IwLC	+30<=n<=+70	00H	(*1)
4CH	Head Actuator Rank ID for IwLM	+30<=n<=+70	00H	(*1)
4DH 5EH	USB ID		00H 00H	(*1) (*1)
5FH	Market ID		00H	EURO/ ASIA: 00H Custom: 02H EAI:10H
60H 7DH	Model Name		00H 00H	- -
7EH	Password		55H	-
7FH	Password		33H	-

NOTE: *1 Adjusted at factory.

7.2 Component Layout

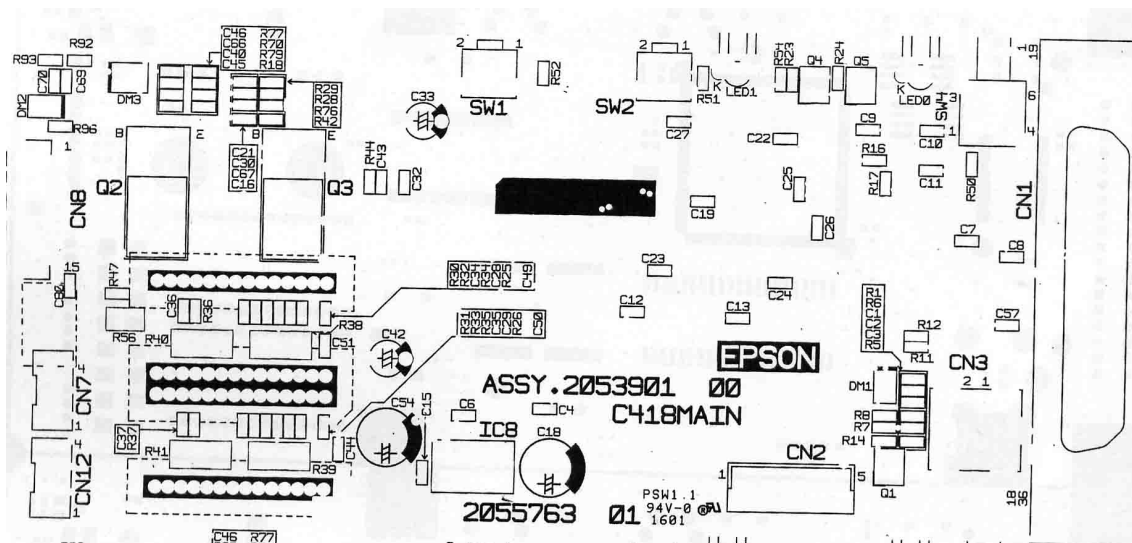

Figure 7-2. C418 Main board component layout (1)

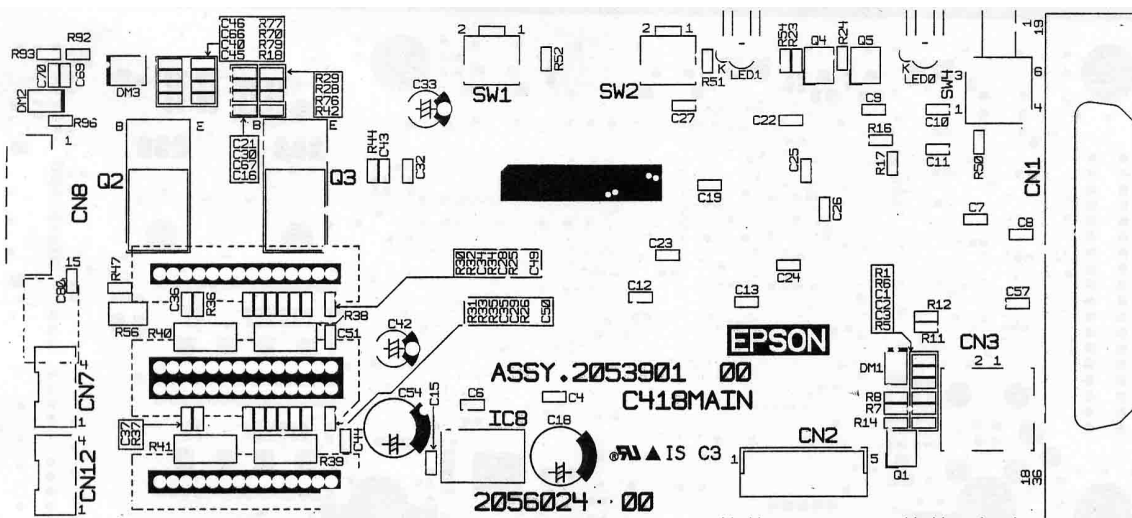

Figure 7-3. C418 Main board component layout (2)

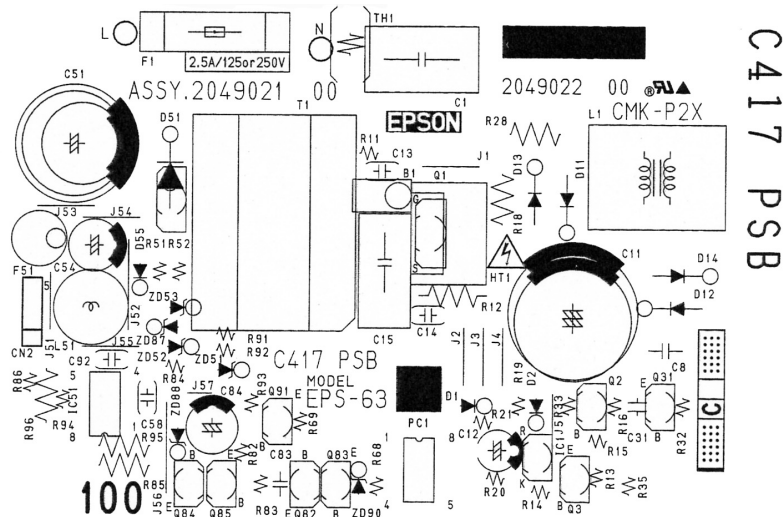

Figure 7-4. C417 PSB board component layout

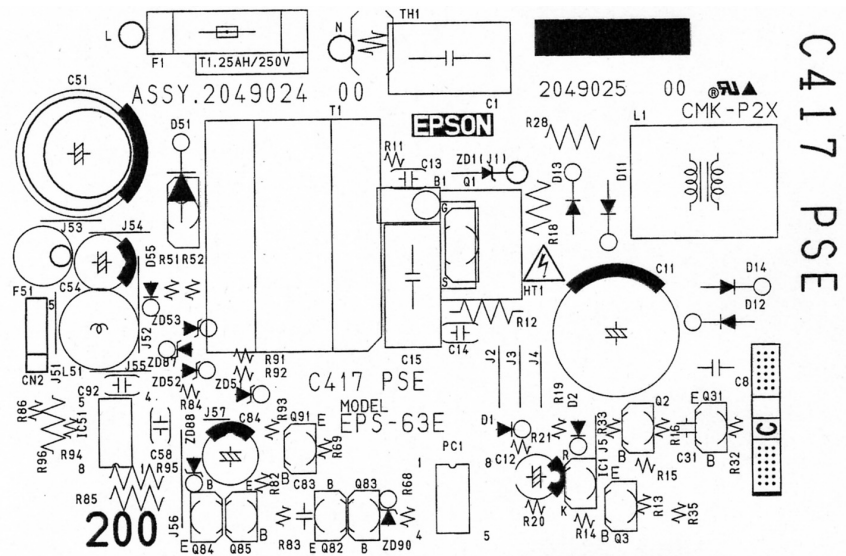
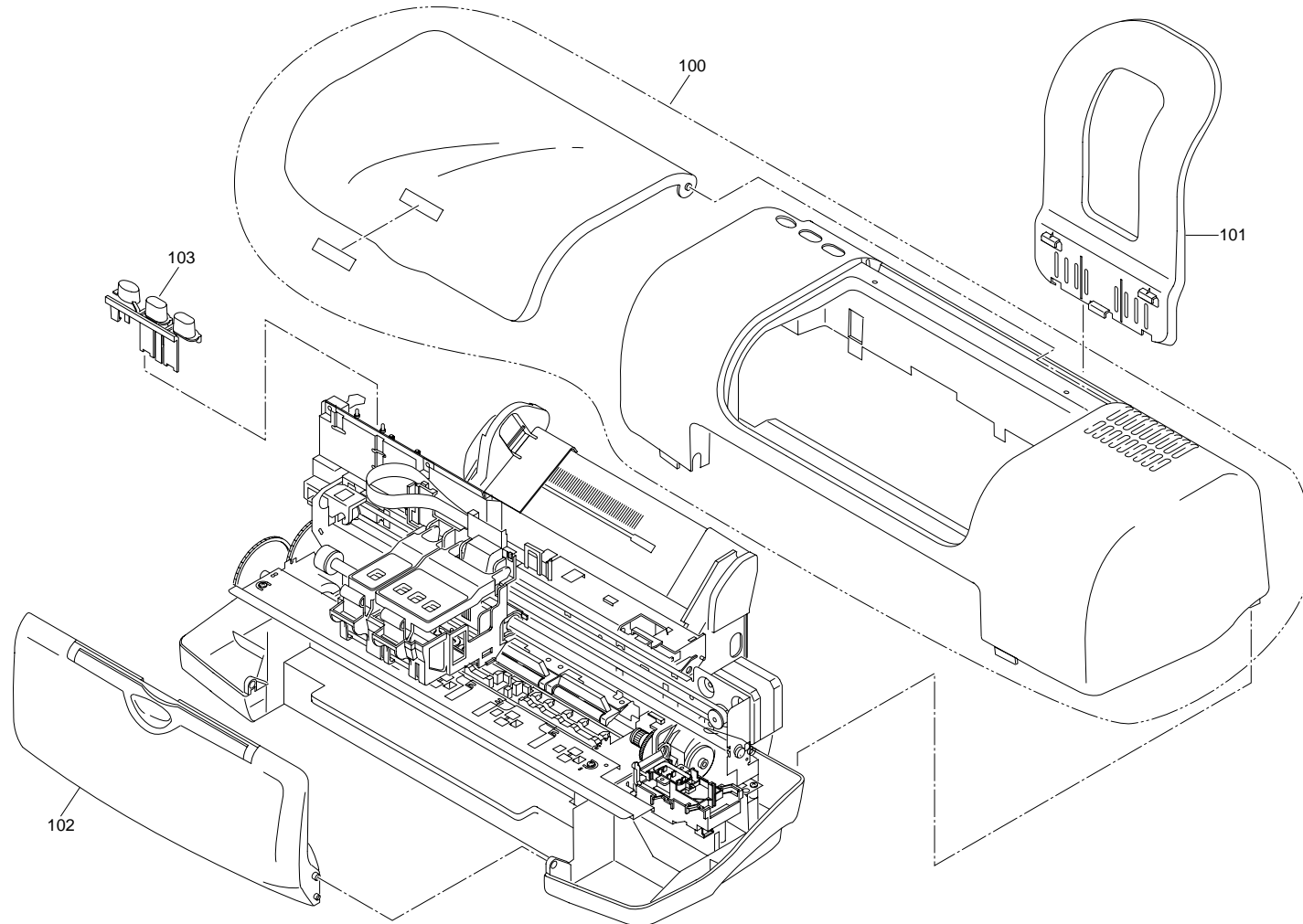

Figure 7-5. C417 PSE board component layout

7.3 Exploded Diagram

Following pages show exploded diagram.



EPSON STYLUS PHOTO 820 / 810

No.1 Rev.01 10330

Figure 7-6. Stylus PHOTO 810/820 Exploded Diagram 1

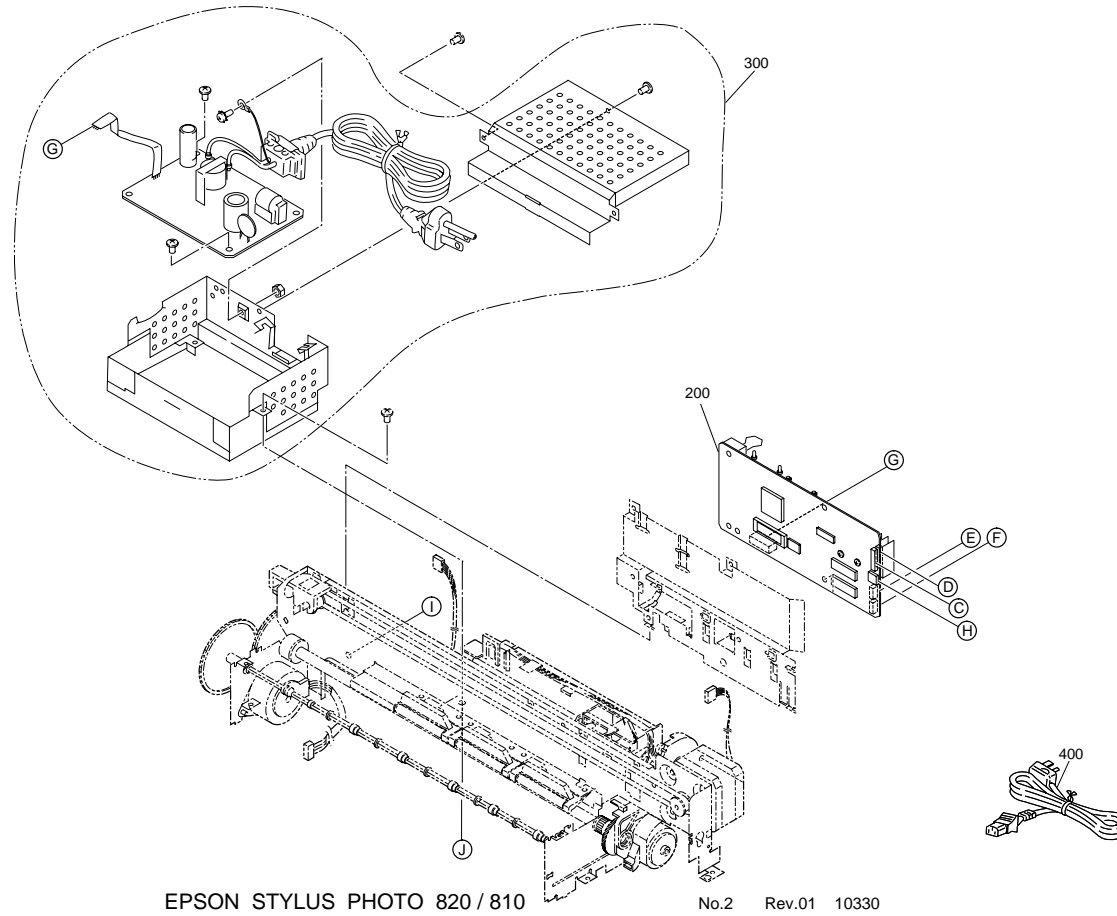
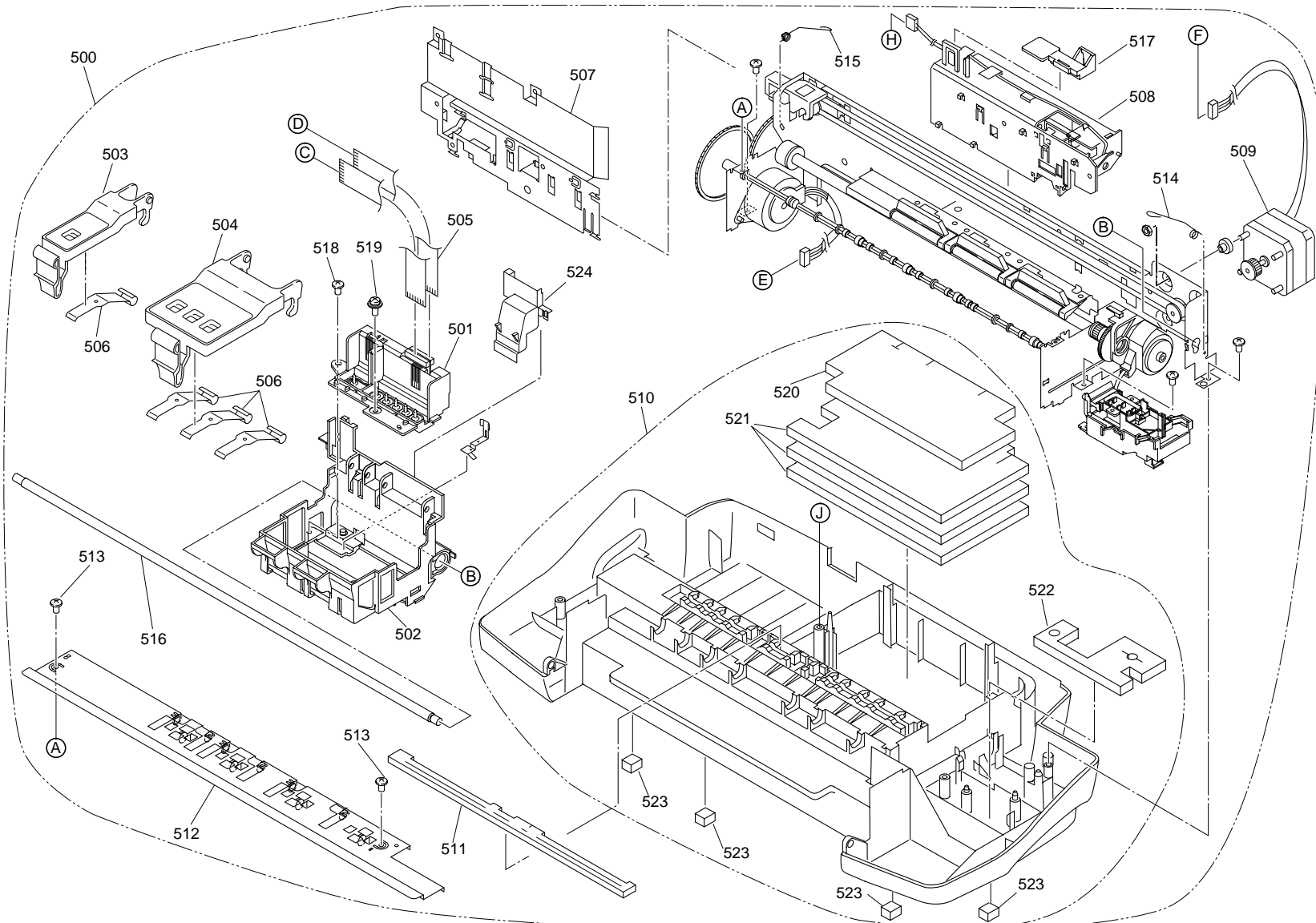

Figure 7-7. Stylus PHOTO 810/820 Exploded Diagram 2



EPSON STYLUS PHOTO 820 / 810

No.3 Rev.02 10330(C417)

Figure 7-8. Stylus PHOTO 810/820 Exploded Diagram 3

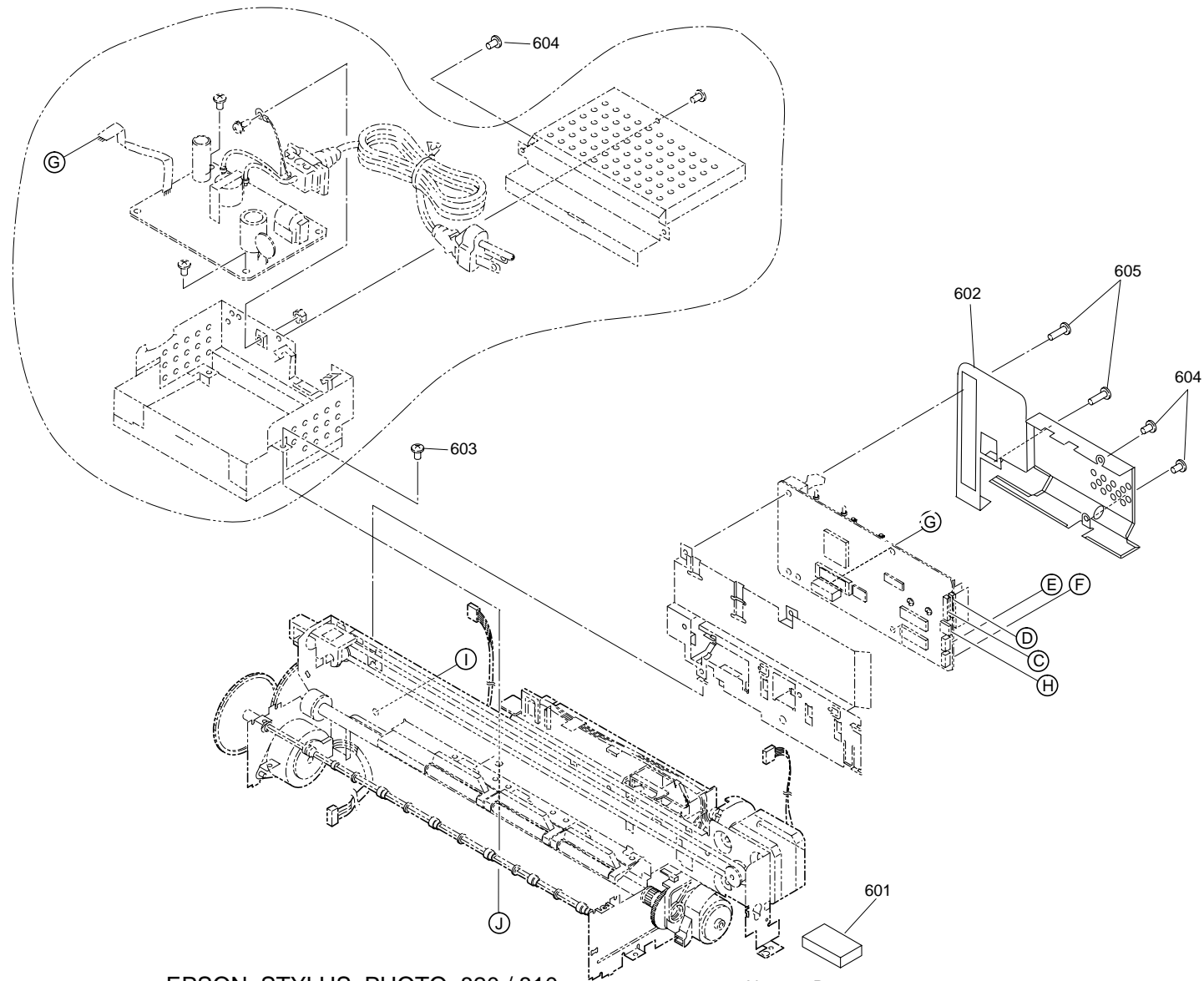

EPSON STYLUS PHOTO 820 / 810

No.4 Rev.01 10330

Figure 7-9. Stylus PHOTO 810/820 Exploded Diagram 4

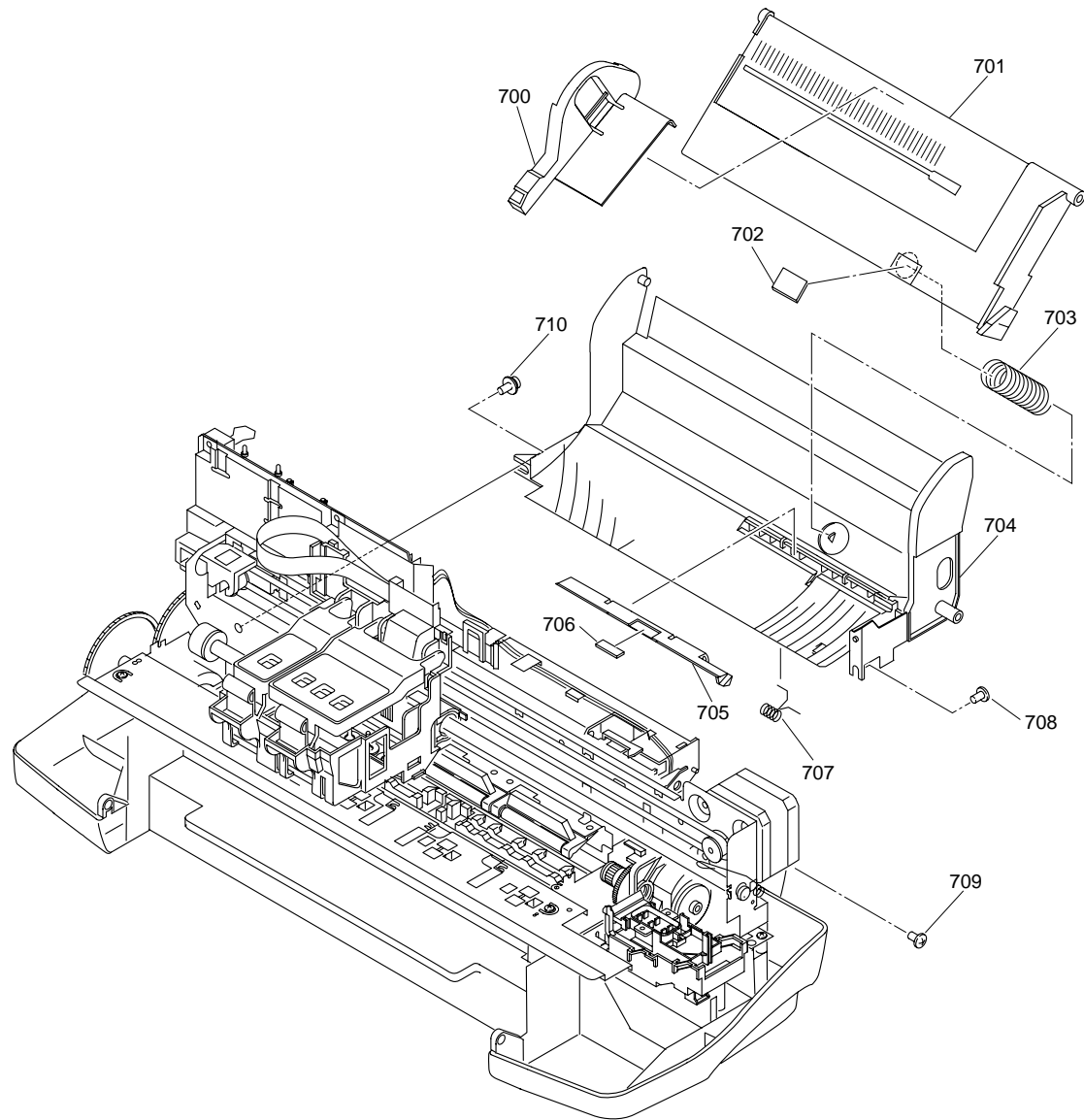

EPSON STYLUS PHOTO 820 / 810

No.5 Rev.01 10330

Figure 7-10. Stylus PHOTO 810/820 Exploded Diagram 5

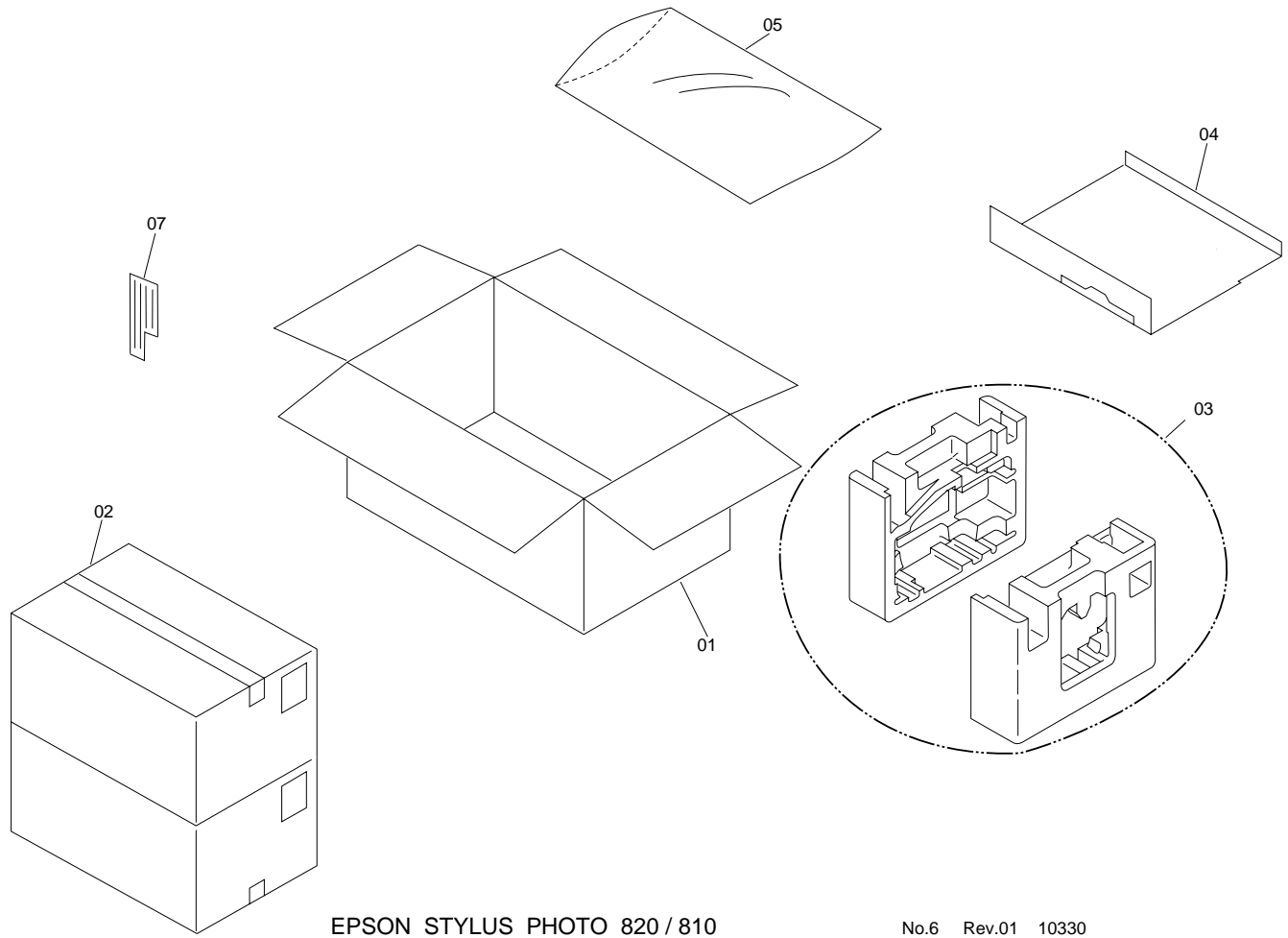

EPSON STYLUS PHOTO 820 / 810

No.6 Rev.01 10330

Figure 7-11. Stylus PHOTO 810/820 Exploded Diagram 6

7.4 Parts List

Table 7-10. Stylus PHOTO 810/820 Parts List

Code	Parts Name
100	HOUSING,UPPER
101	COVER,PRINTER
102	PAPER SUPPORT
104	LOGO PLATE 10X40;C
105	BUTTON,SW;EFS
106	STACKER
107	STACKER,SUPPORT,UPPER
108	STACKER,SUPPORT,MIDDLE
109	SHAFT,STACKER
200	BOARD ASSY.,MAIN
300	POWER SUPPLY ASSY.,C418;120V
500	PRINTER MECHANISM(ASP)MA610-100
501	PRINT HEAD
502	CARRIAGE
503	COVER,CARTRIDGE,BK;B
504	COVER,CARTRIDGE,C
505	CABLE,HEAD
507	MOUNTING PLATE,M/B
508	HOLDER,SHAFT ASSY.,C418
509	MOTOR ASSY.,CR
510	HOUSING,LOWER
511	FOOT

Table 7-10. Stylus PHOTO 810/820 Parts List

Code	Parts Name
512	FRAME,FRONT ASSY.,C418
514	TORSION SPRING RIGHT,SHAFT,CR GUIDE
515	TORSION SPRING LEFT,SHAFT,CR GUIDE
516	SHAFT,CR,GUIDE
517	SPACER,FFC
518	PLATE SPRING,COVER,CARTRIDGE
519	HOLDER,CABLE HEAD;B
604	C.B.P-TITE SCREW,3X8,F/ZN
605	C.B.S. SCREW(B300204211)
606	+ BIND B-TITE SEMS W2,2.5X5,F/ZB
700	EDGE GUIDE
701	HOPPER
702	PAD,HOPPER
703	COMPRESSION SPRING,2.50
704	FRAME,ASF
705	HOLDER,PAD
706	PAD,LD;D
707	TORSION SPRING,29.1
708	POROUS PAD,INK EJECT
709	POROUS PAD,TUBE,STOPPER
710	POROUS PAD,CAP,LOWER
711	C.B.S. SCREW(B300204211)
712	C.B.P-TITE SCREW,3X8,F/ZN
713	SHIELD PLATE,M/B
714	C.B.S. SCREW(B300204611)

Table 7-10. Stylus PHOTO 810/820 Parts List

Code	Parts Name
1	INDIVIDUAL CARTON BOX FOR AMERICA
3	PAD,PRINTER
4	PAD,ACCESSORY
5	PLASTIC PROTECTIVE BAG,650X420X0.03T
7	PAD,CR

7.5 Electrical Circuits

The electric circuit diagrams below are shown at the following pages:

- C418 Main/Main-B control circuit board
- C417 PSB/PSE power supply circuit board

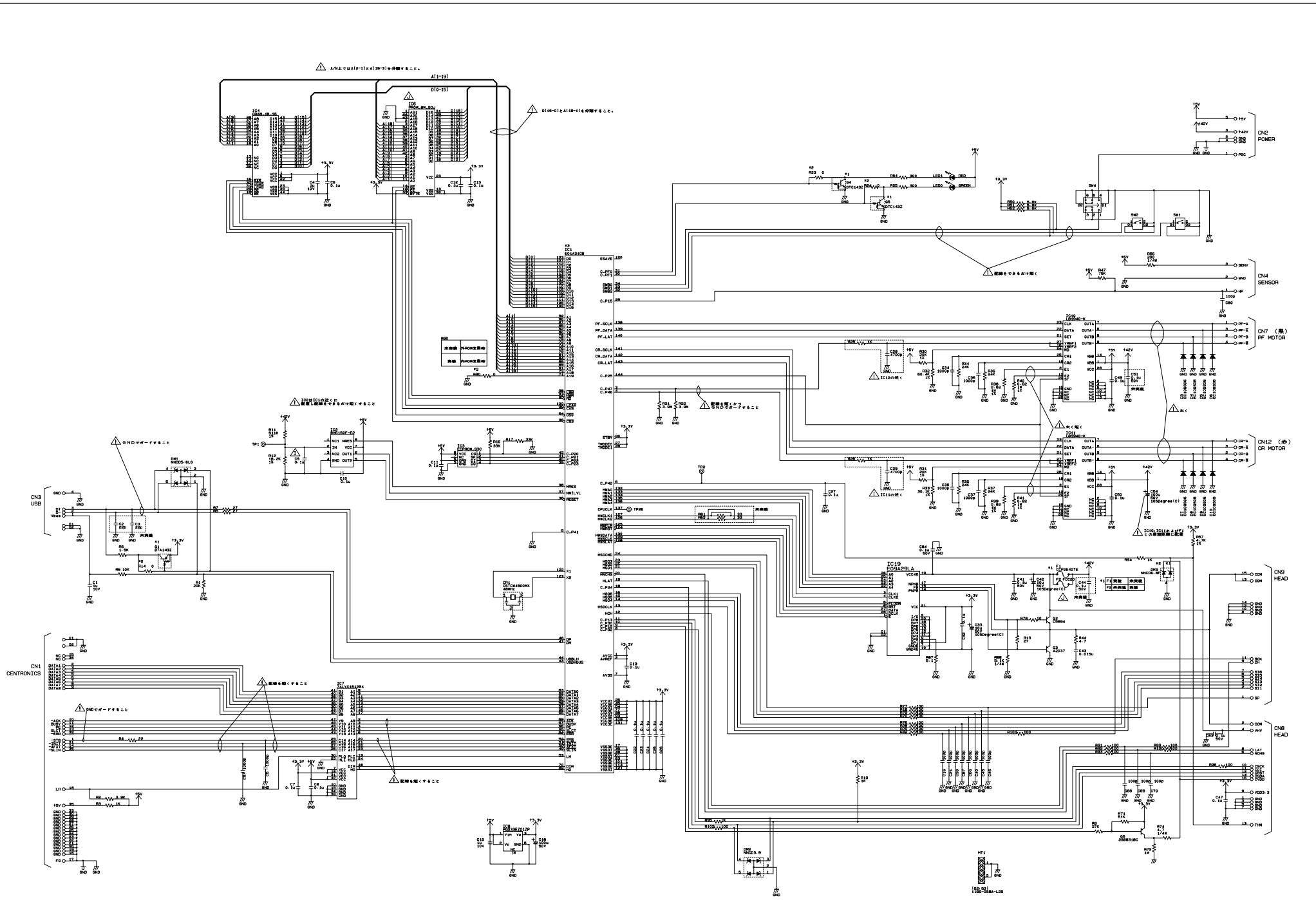

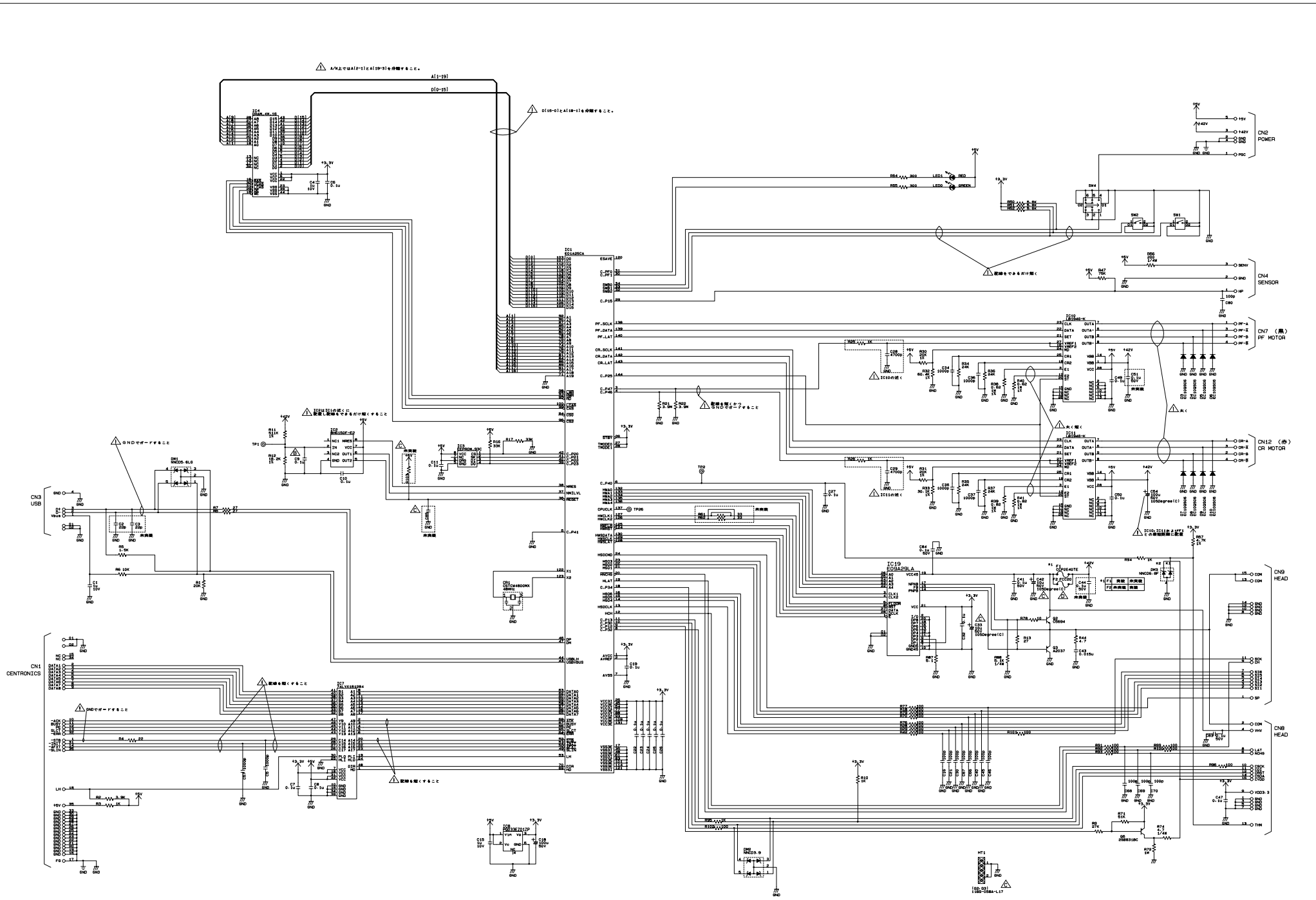

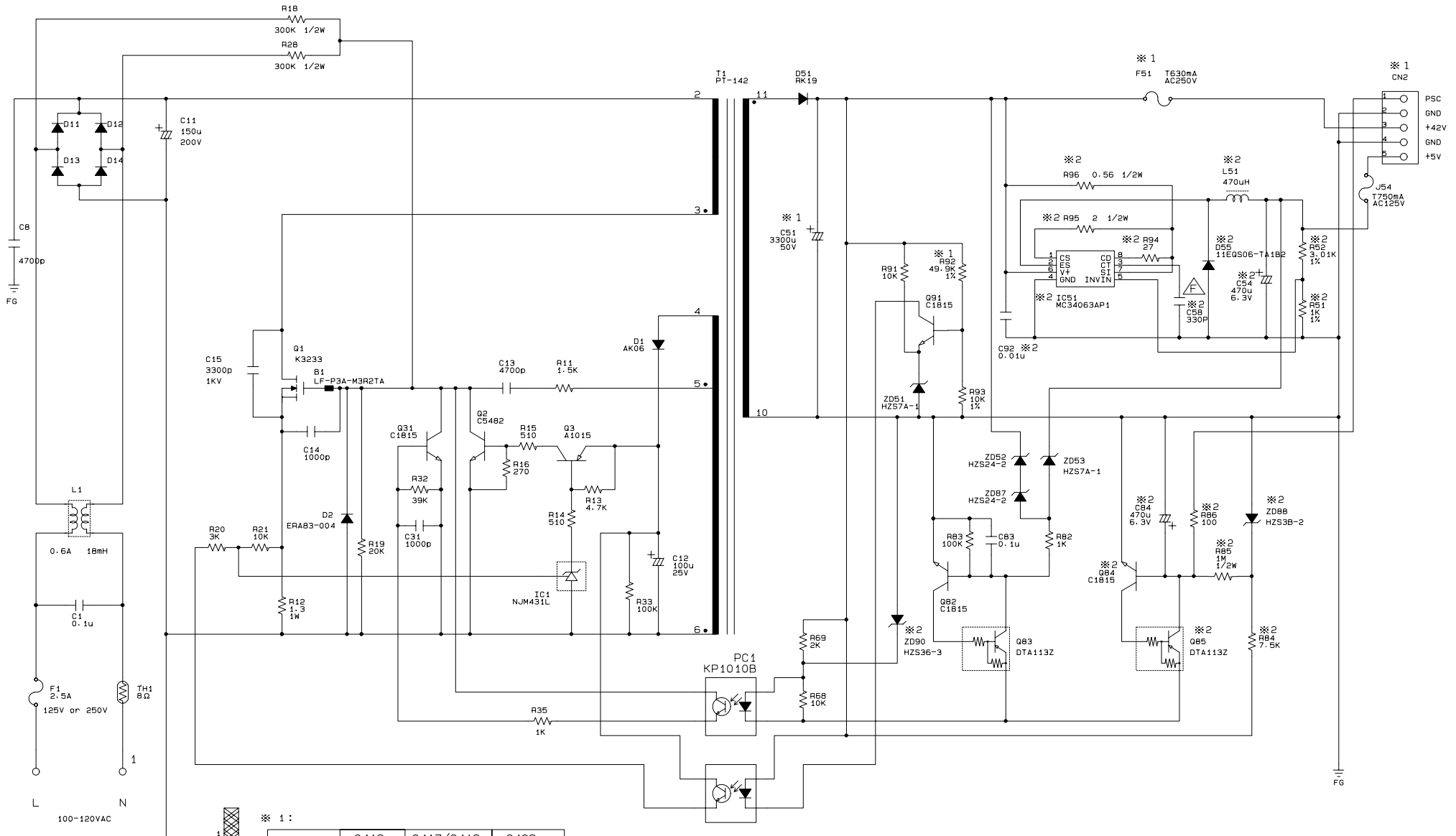

※ 1 :

	C413	C417/C418	C429
C51	1000 μ	3300 μ	3300 μ
F51	1.25A	630mA	630mA
R92	41.2K	49.9K	41.2K
CN2 1pin	NC	PSC	PSC
CN2 3pin	+36V	+42V	+36V
J54	Jumper Wire	750mA 125V	750mA 125V

※ 2 : The following components are mounted on C417/C418/C429 PSB BOARD.
 IC51, R51, R52, R84, R85, R86, R94, R95, R96, C54, C58, C84, C92, Q84, Q85, ZD88,
 ZD90, D55, L51

Model : Stylus Photo 810/820
 Board : C417 PSB
 Sheet : 1 of 1
 Rev. : F

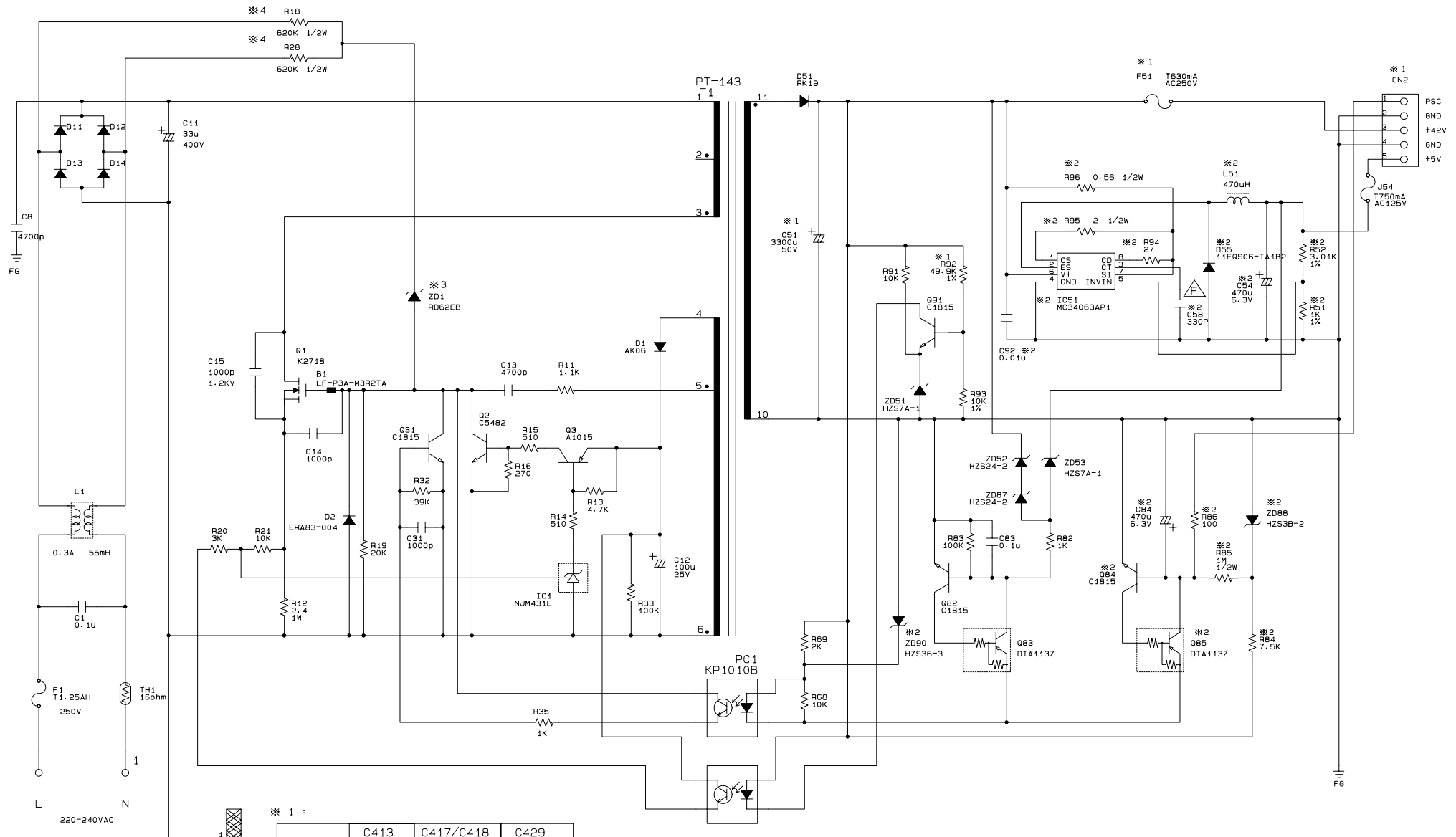

※ 1 :

	C413	C417/C418	C429
C51	1000 μ	3300 μ	3300 μ
F51	1.25A	630mA	630mA
R92	41.2K	49.9K	41.2K
CN2 1pin	NC	PSC	PSC
CN2 3pin	+36V	+42V	+36V
J54	Jumper Wire	750mA 125V	750mA 125V

- ※ 2 : The following components are mounted on C417/C418/C429 PSE BOARD.
 IC51, R51, R52, R84, R85, R86, R94, R95, R96, C54, C56, C84, C92, Q84, Q85, ZD88, ZD90, D55, L51
- ※ 3 : [ZD1] is mounted on C417 PSE BOARD for Korea.
- ※ 4 : [R18, R28] are mounted as follows.
 For Korea : 220KΩ.1/2W
 For 220-240V Standard : 620KΩ.1/2W

Model : Stylus Photo 810/820
 BOARD : C417 PSE
 Sheet : 1 of 1
 Rev. : F